



PRECISION IN EVERY DETAIL



DUY TAN PRECISION MOLD



Company Overview

SNAPSHOTS

- ▶ Taken apart from DUYTAN group since 2017.
- ▶ Twenty-two-year experiences in plastic mold design and manufacture, provide our customers comprehensive solution through closed processes from mold design, making mold, testing samples, manufacturing plastic products with injection and blowing processes, printing, labeling and delivery.
 - ▶ Annual output: 240 - 300 high quality sets.
 - ▶ 2019: Certificate on High Technology Enterprise issued by Ministry of Science & Technology.

Highlights

- *HQ Area: 8,250 m²*
- *Existing staff: 120 ppl (35 engineers)*
- *Main products: Precision molds*
- *Capacity: 240 - 300 sets/year*
- *Mold warrantee policy: up to 2 million shots depend on customer requirements.*
- *Mold precision: $\leq 5 - 10 \mu\text{m}$*



Company Overview

VISION

- *To become a leading mold supplier in South East Asia.*

MISSION

- *To produce exquisite and high quality plastic products that meet our customers' requirements*

CORE VALUES

- *Creation – Speed – Quality – Discipline*



OUR SERVICES

- Product design & concept to realization: Solution & 2D & 3D
- Reverse engineering & rapid prototype
- Mold design: analysis DFM (Design For Manufacturing), Moldflow Insight simulation
- Pilot mold manufacturing
- Production mold manufacturing
- Mold qualification



SEGMENTS SERVED

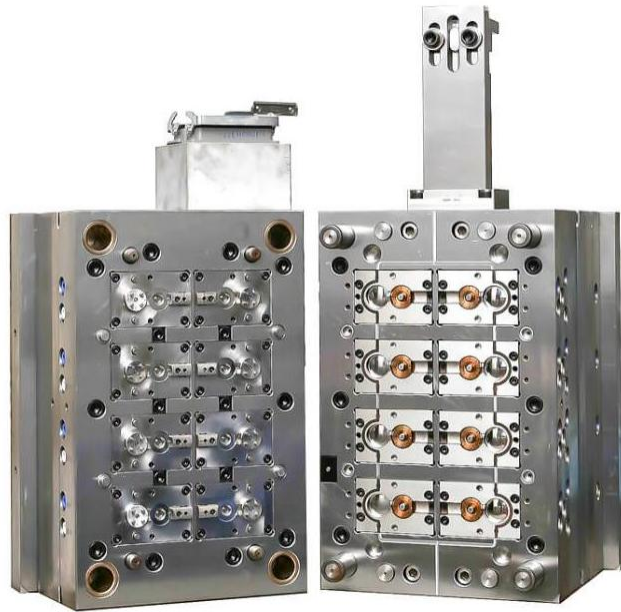

Injection molds for Caps &
Closures

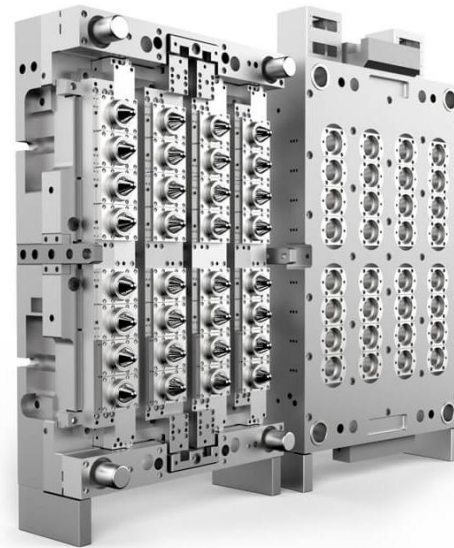

Injection molds for
preform packaging



Blowing molds for cosmetics jars /
bottles

A produces about 300 sets of high precision molds per year



Our Partners & Customers

<p>MACHINES/ EQUIPMENTS</p>						
<p>SOFTWARES</p>						
<p>CUSTOMERS</p>						
						



MOLD MANUFACTURING OVERVIEW

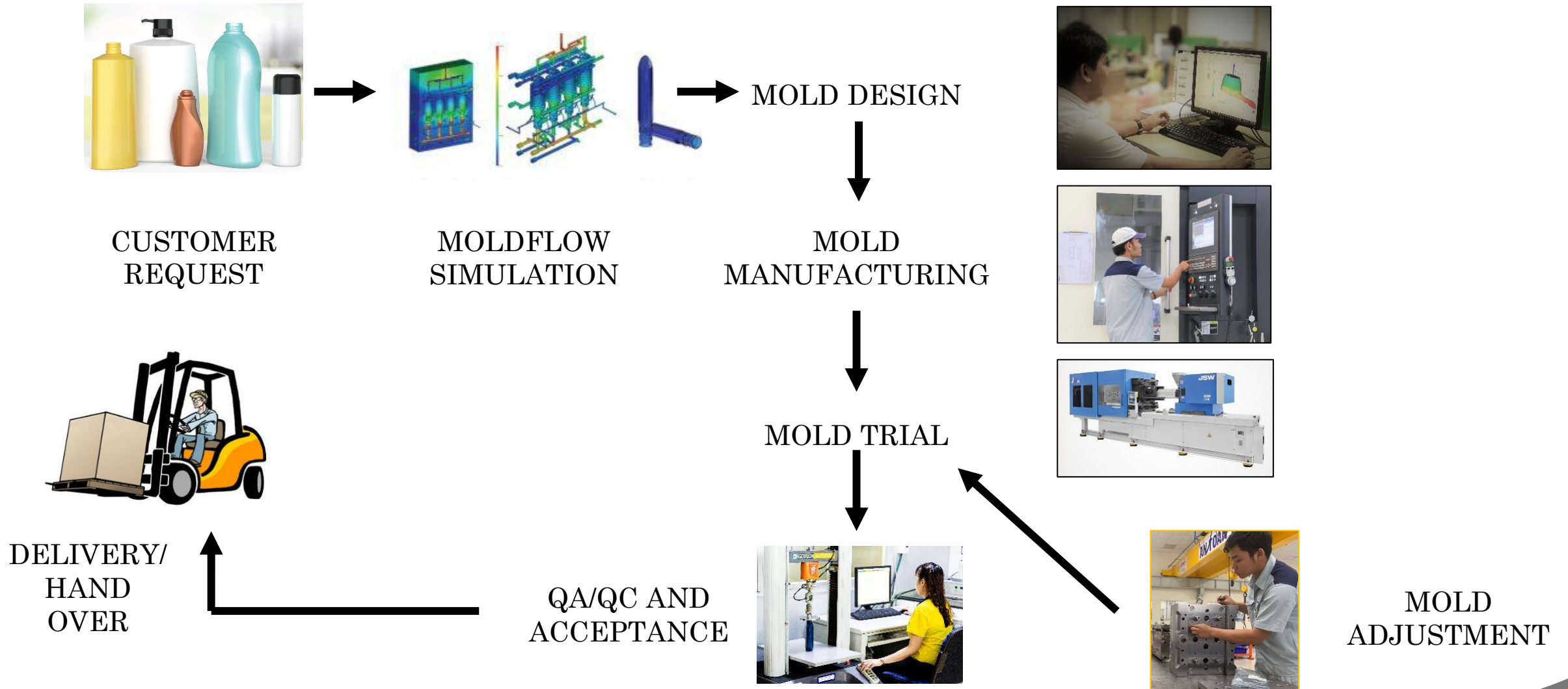



ANALYSIS & DESIGNING PROCESS

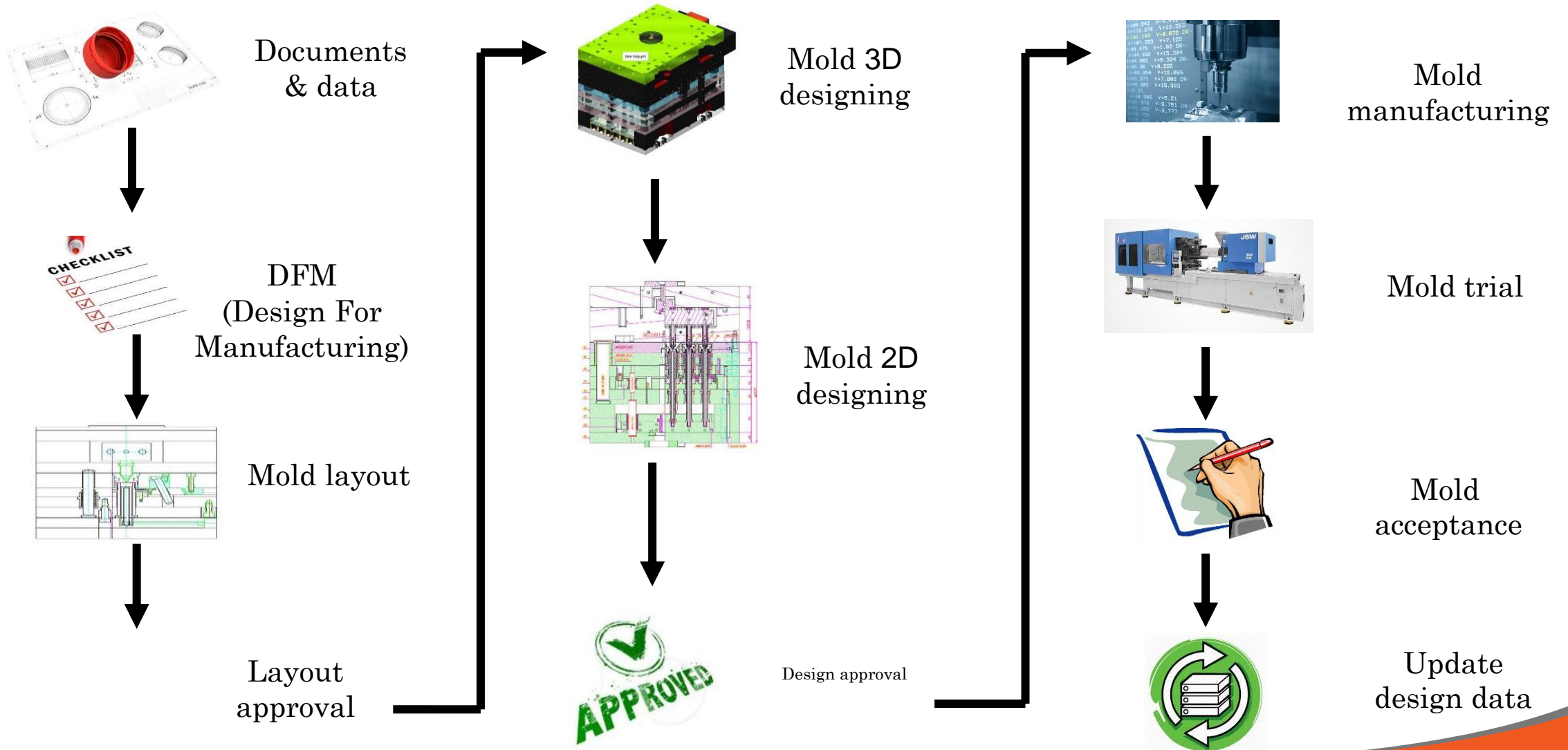



MANUFACTURING PROCESSING

Steel & materials

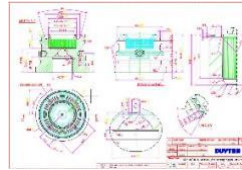
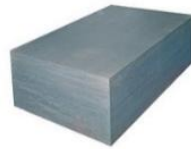

Manufacturing processing analysis basing on 3D&2D

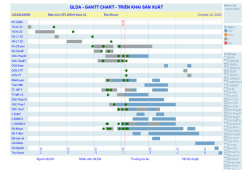

Processing scheduling



Mold components

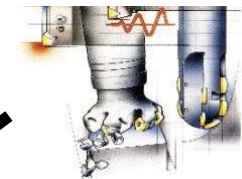

Rough machining
(Raw steel, rough milling & turning)



Inserts finish machining
(Milling, turning, EDM, grinding, ...)

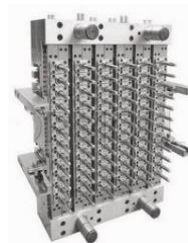

Mold completing
(QC, polishing, assembly)



DESIGNING & PROCESS PROGRAMMING

- R&D: **6** engineers
- Designing & process programming: **13** engineers
- Technical analysis & design:
 - Pro Creo
 - Unigraphics
 - Hyper Mill
 - AutoCAD 2018
 - Mold Flow Insight 2021

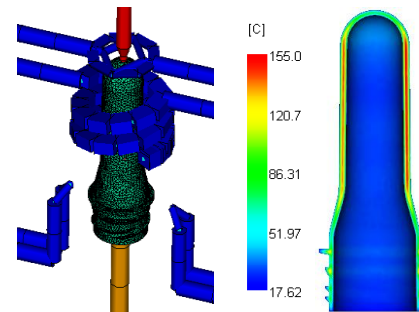
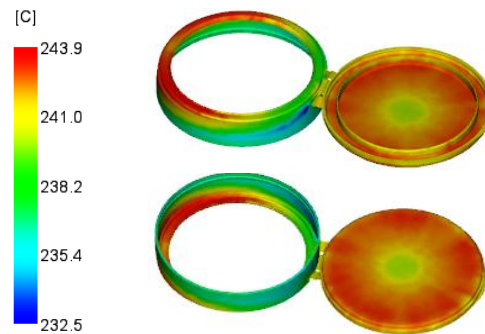



PROCESSING MANAGEMENT

Production Smoothing by ISS Software

Seq	W/C	Description	Sub	Hrs	FA	StartbyDate	QtyIn	QtyDone	HrsToday	Status	LastDate
1	01	KH-CB phoi	Mua phoi vôi	1.33	30	07/15	8	8.0	00	C	13/07/15 14:53:41
2	01	Kho-GiaoVT	Kho cấp vật tư cho xưởng	1.33	01	08/15	8	8.0	05	C	14/07/15 09:13:49
3	15	GCK-Cua	Chuẩn bị phôi	2.00	01	08/15	8	8.0	05	C	14/07/15 09:13:56
4	20	CNC-TienBT	Tiền hành kế hoạch sản	12.00	05	08/15	8	8.0	18	C	05/08/15 08:31:37
5	21	CNC-TienBT	Tiền CNC bản tinh M2	4.00	05	08/15	8	0.0	3.65	C	05/08/15 08:31:45
6	25	CNC-PhayBT	Phay bản tinh-khoản lỗ kim	12.00	06	08/15	8	8.0	38	C	12/08/15 13:50:33
7	30	CNC-TienBT	Tiền công trong phay không được	4.00	07	08/15	8	8.0	00	C	16/11/15 11:01:32
8	35	TT-PhayT	Phay rãnh nước	2.67	13	08/15	8	8.0	9	C	13/08/15 14:59:29
9	36	GCK-Taro	Taro	1.33	15	08/15	8	8.0	1	A	13/08/15 14:59:18
10	40	DK-khuon	Đo kiểm chi tiết khuon	40	17	08/15	8	0.0	43	C	14/08/15 13:52:30
11	45	GK Ngồi	nhật luyện	00	18	08/15	8	8.0	00	Recd	15/08/15 15:40:43
12	50	DK-khuon	Đo kiểm chi tiết khuon	40	20	08/15	8	8.0	12	C	15/08/15 16:49:49
13	55	TT-MP-T	Mã tinh 2 mặt	6.00	20	08/15	8	8.0	4	C	17/08/15 15:42:10
14	60	GCK-Laser	khắc số phần bất	67	21	08/15	8	8.0	1	A	15/08/15 13:36:16

Dashboard Online Direct Management

The Gantt chart, titled 'QLDA - GANTT CHART - TRIỂN KHAI SẢN XUẤT', shows a project timeline for 'Nắp chai LITS 200ml Bọc K1'. The chart includes a list of tasks such as 'KH-DuKH', 'TK-Kh-3D', 'CNC-PhayBT', and 'GCK-Taro' with their respective start and end dates. A secondary bar chart below shows 'TOTAL' resource utilization from 18/08 to 28/08, with a peak in early September.

IoT

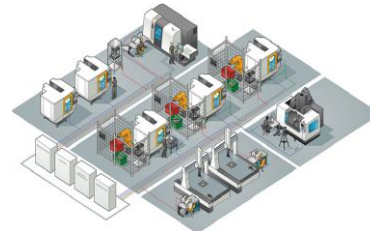



TECHNOLOGY



- Human : 120
- CNC milling : 12 machines
- CNC lathe : 7 machines
- EDM & WEDM : 7 machines



Processing: Rough & Finish Machining

*Milling machine
CNC MAZAK
FJV-35/80II*



*Milling machine
CNC MAZAK-
FJV-60/80II*



*Milling machine
CNC MAZAK-
VCS530*



Gun Drill machine





Processing: Grinding



Flat grinding machine
Okamoto ACC450



Circular grinding machine
Palmary GU32X60S



Processing: Finish Machining



Milling machines CNC 5 axis
Makino D500 (Japan)

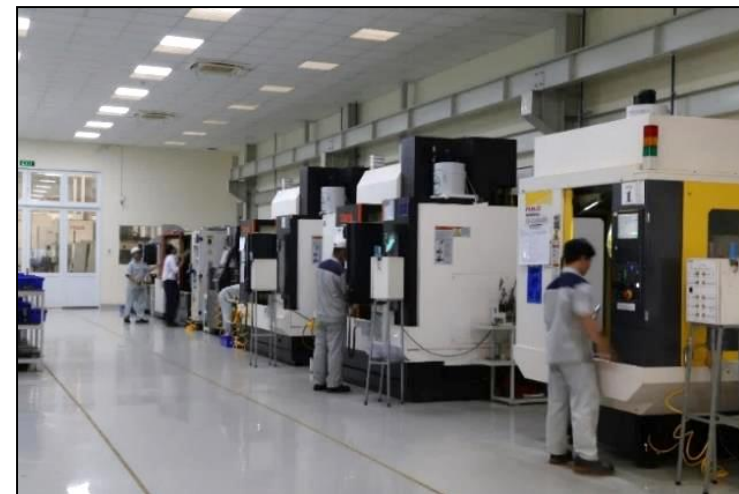



Processing: Finish Machining

LATHE MACHINE CNC MAZAK

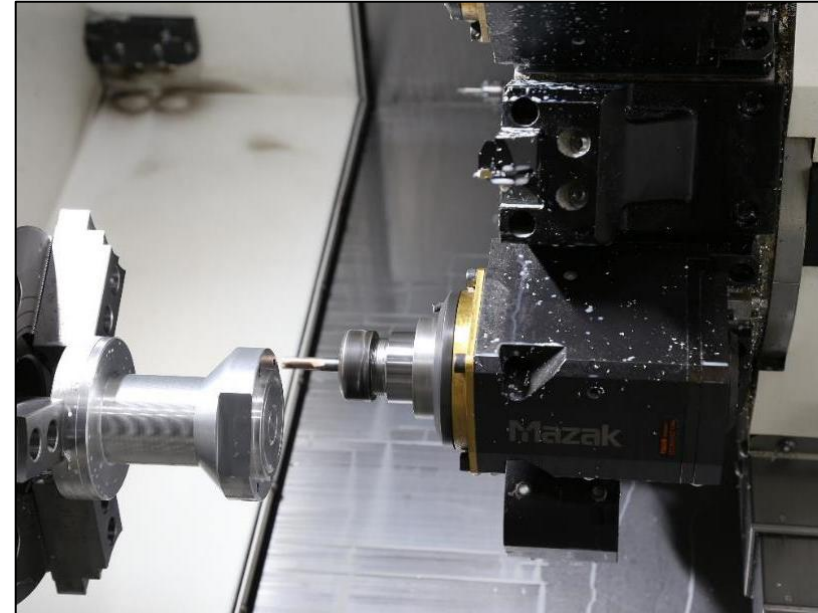

Lathe machine CNC Mazak QT300 MA, with C milling axis (Japan)



Processing: Finish Machining

EDM MACHINES



EDM Charmilles Roboform 35P
(Switzerland)



EDM Sodick AG40L
(Japan)



Processing: Finish Machining

WEDM MACHINES



Charmilles Robofil 380 (Switzerland)



Makino U3 (Japan)



MOLD TESTING MACHINES



JSW (JAPAN)



Krauss Maffei (GERMANY)



QUALITY ASSURANCE



**Projector
Measuring -
Mitutoyo**



**Coordinate Measuring Machine
(CMM) - Mitutoyo**



**Height measuring
machine - Zoller**



**Hardness
testing machine**



CAP & CLOSURE





INJECTION MOLD

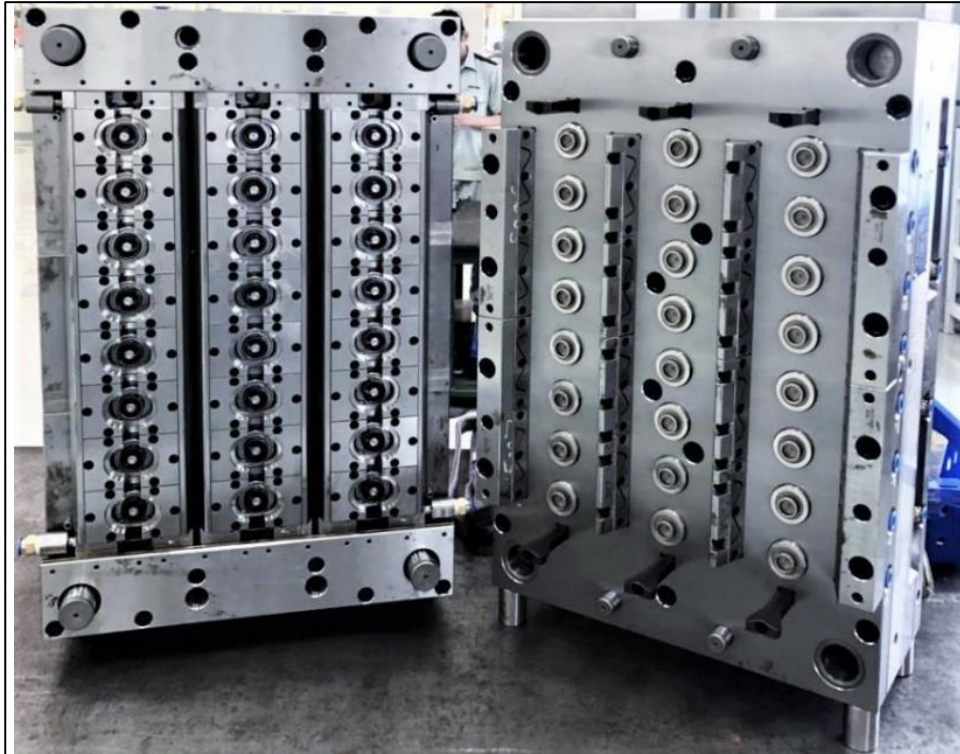

- Product : Effervescent tablets cap D31.9
- No. of cavity : 24 cav
- Resin : LDPE
- Part weight : 4.7g
- Machine: JSW ADS 180 T
- Cycle time: 24s
- Mold size: 700 x 500 x 597 (L x W x H)

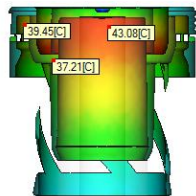
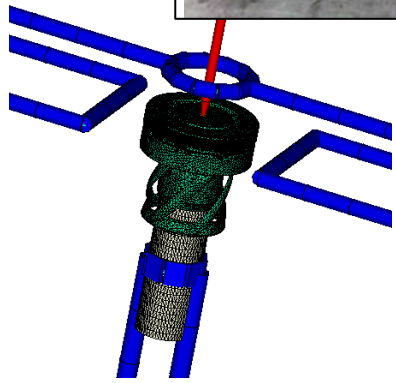



INJECTION MOLD

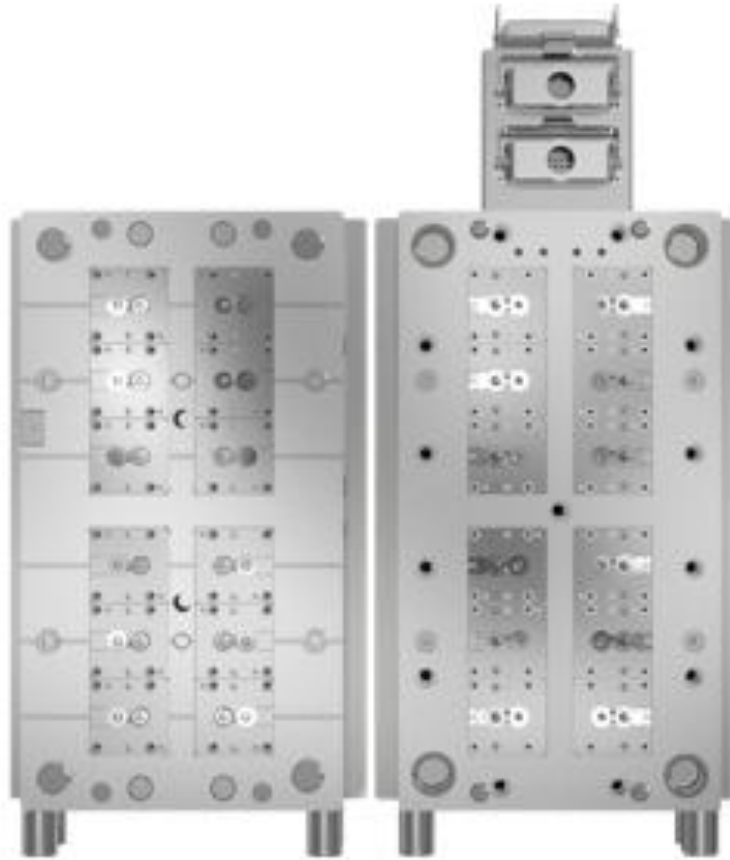

- Product : Fish Sauce Cap 12Cav
- No. of cavity : 12 cav
- Resin : HDPE
- Part weight : 2,4g
- Machine: JSW 100 T
- Cycle time: 20s
- Mold size: 650x350x468 (L x W x H)



INJECTION MOLD

- Product: Chili Sauce cap D25
- No. of cavity: 12 cav
- Resin: PP
- Part weight: 2.6g
- Machine: JSW ADS 180
- Cycle time: 20,5s
- Mold size: 910x550x495 (L x W x H)

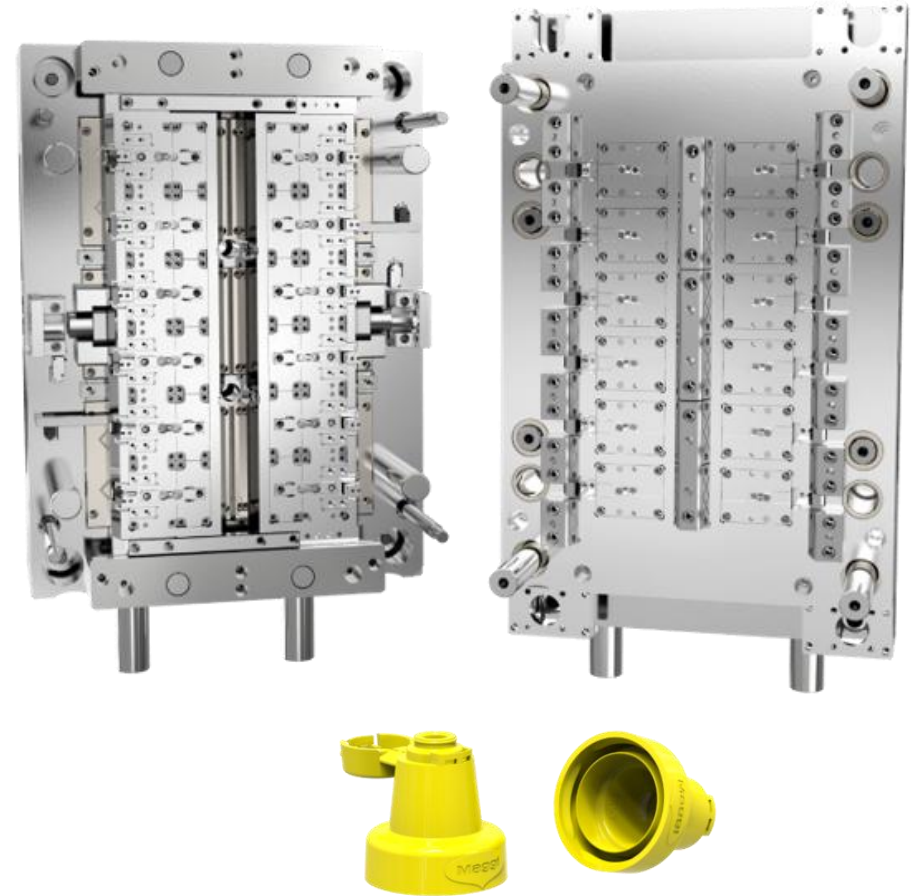



INJECTION MOLD

- Product: Soy sauce cap D30
- No. of cavity: 16 cav
- Resin: LDPE
- Part weight: 5.6g
- Machine: JSW ADS 450
- Cycle time: 20s
- Mold size: 1000x850x665 (L x W x H)

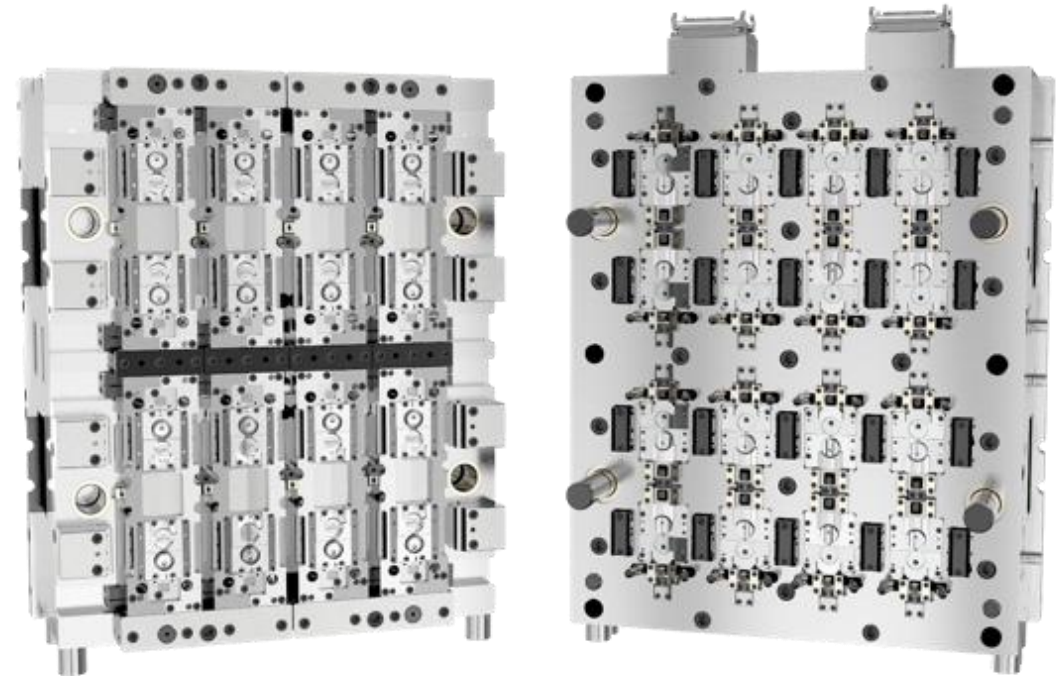



INJECTION MOLD

- Product: Edible oil fliptop cap D028 PCO1881
- No. of cavity: 16 cav
- Resin: LDPE & HDPE
- Part weight: 6.7g
- Machine: JSW ADS 180
- Cycle time: 18s
- Mold size: 750x490x521 (L x W x H)

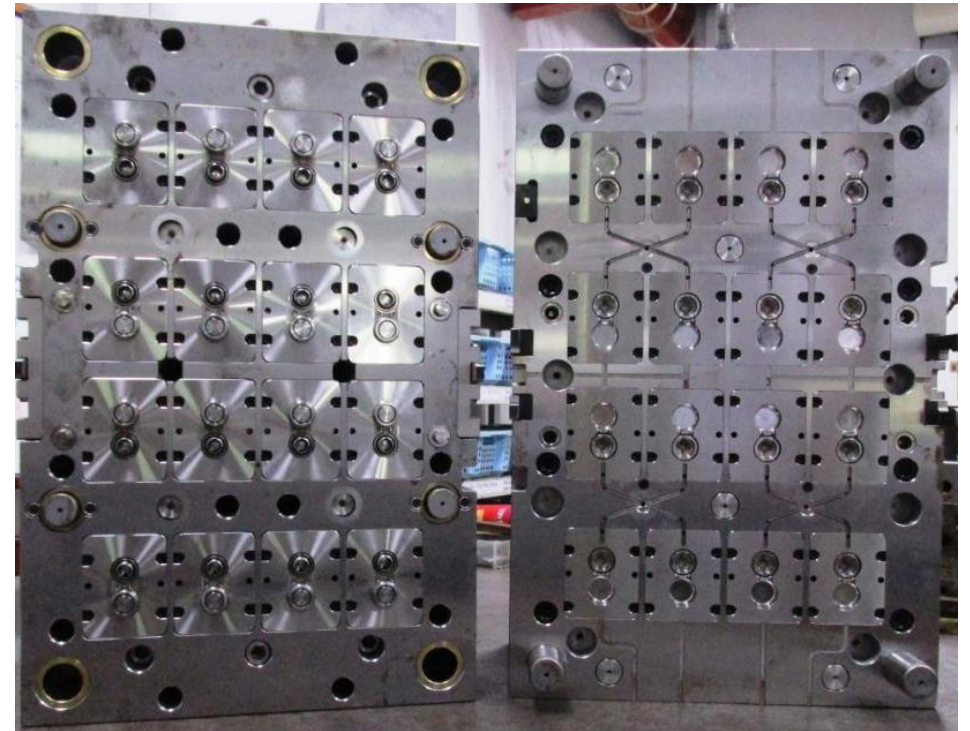



INJECTION MOLD



- Product: Fliptop 8oz Tall Snap On
- No. of cavity : 12cav
- Resin: PP
- Part weight: 13.6g
- Machine: JSW ADS 350
- Cycle time: 18s
- Mold size: 1050x700x527 (LxWxH)



INJECTION MOLD



- Product: Cap D60 stack mold
- No. of cavity: 16
- Resin: PP
- Part weight: 4.9g
- Machine: JSW ADS 110
- Cycle time: 12.5s
- Mold size: 550 x 400 x 446.8 (L x W x H)



INJECTION MOLD

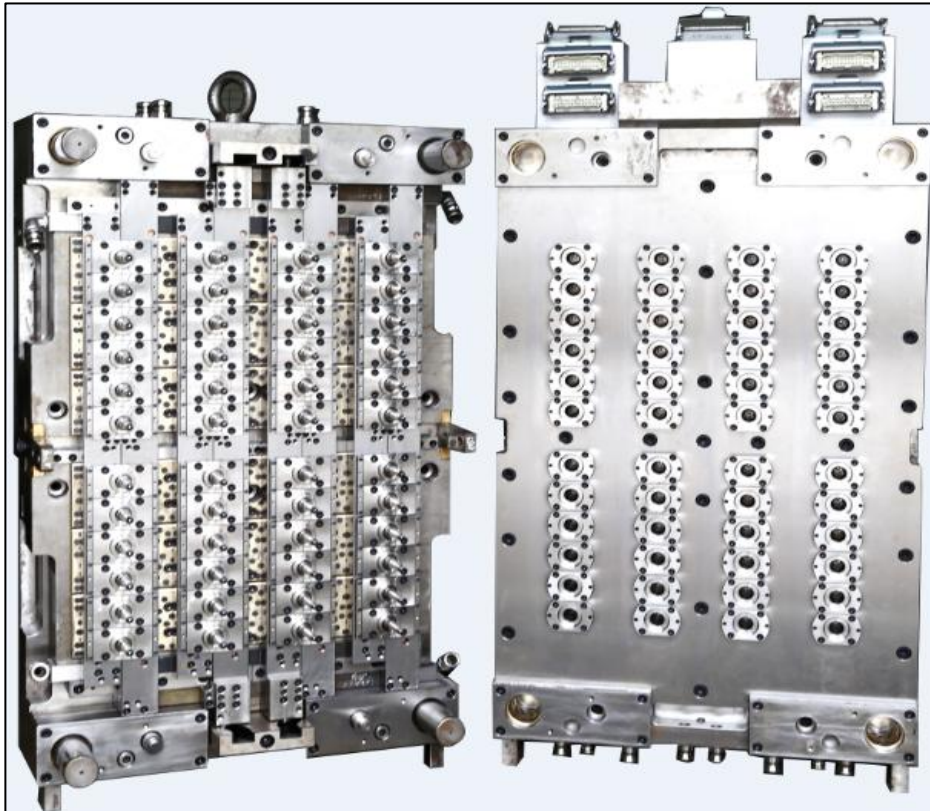

- Product: Preform D30 P30
- No. of cavity: 48cav
- No. of cavity: PET
- Part weight: 30g
- Machine: JSW ADS 450
- Cycle time: 30s
- Mold size: 1150x790x651 (L x W x H)



INJECTION MOLD

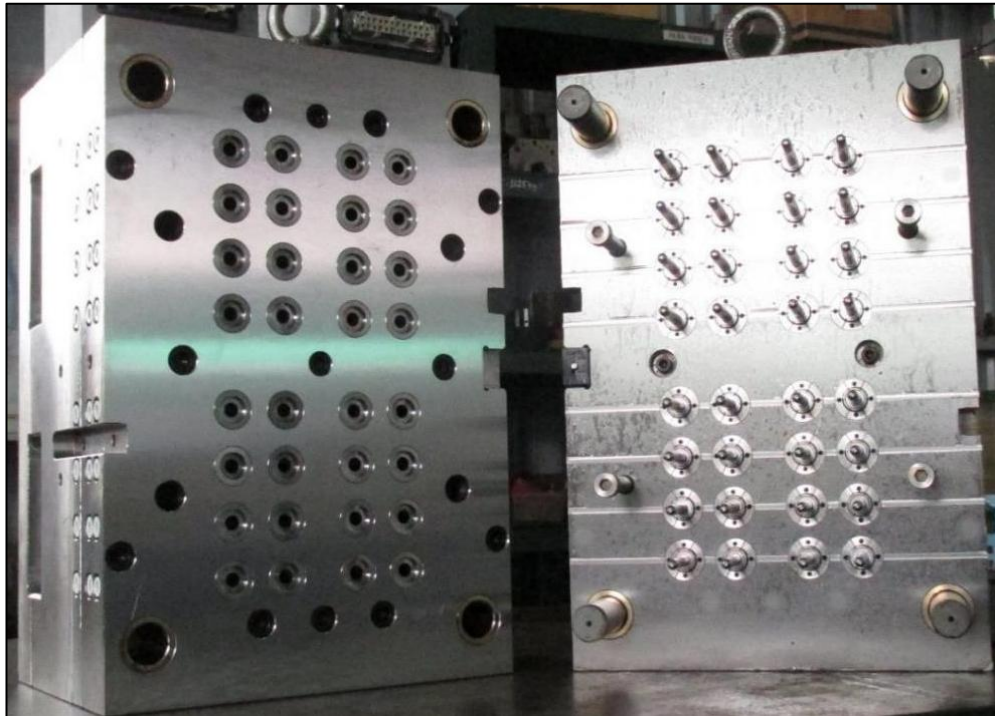

- Product: Blood tube
- No. of cavity: 32 cav
- Resin: PP
- Part weight: 2.2g
- Machine: Krauss Maffei 80
- Cycle: 8s
- Mold size: 600x400x443 (L x W x H)



BLOWING MOLD

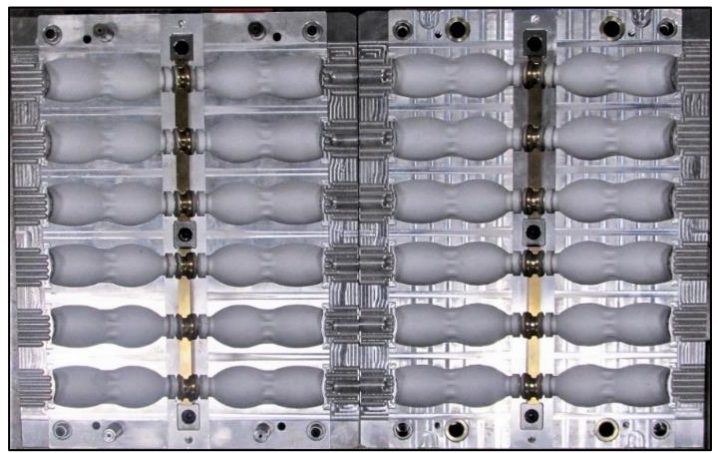

- No. of cavity: Max 14 cav
- Volume: 50ml -> 25 Litre





ISO CERTIFICATE

COMPANY MANAGEMENT SYSTEMS



bsi.  

Certificate of Registration

QUALITY MANAGEMENT SYSTEM - ISO 9001:2015

This is to certify that: **DUY TAN PRECISION MOLD COMPANY LIMITED**
Lot 1, Street 1A, Tan Tao Industrial Park,
Tan Tao A Ward, Binh Tan District,
Ho Chi Minh City,
Vietnam

Holds Certificate Number: **FM 721416**

and operates a Quality Management System which complies with the requirements of ISO 9001:2015 for the following scope:

The design, manufacture and supply of molds.

For and on behalf of BSI: 
Michael Lam
Managing Director Assurance, APAC

On behalf of BSI Vietnam: 
Le Duyen Anh
Managing Director Vietnam

Original Registration Date: **20/02/2020**
Latest Revision Date: **15/02/2023**

Effective Date: **20/02/2023**
Expiry Date: **19/02/2026**

Page: 1 of 1

    ...making excellence a habit™

This certificate was issued electronically and remains the property of BSI and is bound by the conditions of contract.
An electronic certificate can be authenticated [online](https://www.bsigroup.com/ClientDirectory). Printed copies can be validated at www.bsigroup.com/ClientDirectory or telephone +44 (0) 30 200 966.
Further clarifications regarding the scope of this certificate and the applicability of ISO 9001:2015 requirements may be obtained by consulting the organization.
This certificate is valid only if provided original copies are in complete set.
Information and Contact: BSI, Kitemark Court, Davy Avenue, Knowlton, Milton Keynes MK5 8PP, UK. Tel: +44 845 080 9000.
BSI Assurance UK Limited, registered in England under number 7805321, at 389 Chiswick High Road, London W4 4AL, UK.
Contact Office: BSI Vietnam Headquarters - 15 Floor APC Tower, 5188 Den Bon Phu Street, Ward 21, Binh Thanh District, Ho Chi Minh City, Vietnam. Telephone: +84 (28) 38 200 066.
A member of the BSI Group of Companies.

bsi.  

Certificate of Registration

ENVIRONMENTAL MANAGEMENT SYSTEM - ISO 14001:2015

This is to certify that: **DUY TAN PRECISION MOLD COMPANY LIMITED**
Lot 1, Street 1A, Tan Tao Industrial Park,
Tan Tao A Ward, Binh Tan District,
Ho Chi Minh City,
Vietnam

Holds Certificate Number: **EMS 721414**

and operates an Environmental Management System which complies with the requirements of ISO 14001:2015 for the following scope:

The design, manufacture and supply of molds.

For and on behalf of BSI: 
Michael Lam
Managing Director Assurance, APAC

On behalf of BSI Vietnam: 
Le Duyen Anh
Managing Director Vietnam

Original Registration Date: **20/02/2020**
Latest Revision Date: **15/02/2023**

Effective Date: **20/02/2023**
Expiry Date: **19/02/2026**

Page: 1 of 1

    ...making excellence a habit™

This certificate was issued electronically and remains the property of BSI and is bound by the conditions of contract.
An electronic certificate can be authenticated [online](https://www.bsigroup.com/ClientDirectory). Printed copies can be validated at www.bsigroup.com/ClientDirectory or telephone +44 (0) 30 200 966.
Further clarifications regarding the scope of this certificate and the applicability of ISO 14001:2015 requirements may be obtained by consulting the organization.
This certificate is valid only if provided original copies are in complete set.
Information and Contact: BSI, Kitemark Court, Davy Avenue, Knowlton, Milton Keynes MK5 8PP, UK. Tel: +44 845 080 9000.
BSI Assurance UK Limited, registered in England under number 7805321, at 389 Chiswick High Road, London W4 4AL, UK.
Contact Office: BSI Vietnam Headquarters - 15 Floor APC Tower, 5188 Den Bon Phu Street, Ward 21, Binh Thanh District, Ho Chi Minh City, Vietnam. Telephone: +84 (28) 38 200 066.
A member of the BSI Group of Companies.

bsi.  

Certificate of Registration

OCCUPATIONAL HEALTH AND SAFETY MANAGEMENT SYSTEM - ISO 45001:2018

This is to certify that: **DUY TAN PRECISION MOLD COMPANY LIMITED**
Lot 1, Street 1A, Tan Tao Industrial Park,
Tan Tao A Ward, Binh Tan District,
Ho Chi Minh City,
Vietnam

Holds Certificate Number: **OHS 721418**

and operates an Occupational Health and Safety Management System which complies with the requirements of ISO 45001:2018 for the following scope:

The design, manufacture and supply of molds.

For and on behalf of BSI: 
Michael Lam
Managing Director Assurance, APAC

On behalf of BSI Vietnam: 
Le Duyen Anh
Managing Director Vietnam

Original Registration Date: **20/02/2020**
Latest Revision Date: **15/02/2023**

Effective Date: **20/02/2023**
Expiry Date: **19/02/2026**

Page: 1 of 1

    ...making excellence a habit™

This certificate was issued electronically and remains the property of BSI and is bound by the conditions of contract.
An electronic certificate can be authenticated [online](https://www.bsigroup.com/ClientDirectory). Printed copies can be validated at www.bsigroup.com/ClientDirectory or telephone +44 (0) 30 200 966.
Further clarifications regarding the scope of this certificate and the applicability of ISO 45001:2018 requirements may be obtained by consulting the organization.
This certificate is valid only if provided original copies are in complete set.
Information and Contact: BSI, Kitemark Court, Davy Avenue, Knowlton, Milton Keynes MK5 8PP, UK. Tel: +44 845 080 9000.
BSI Assurance UK Limited, registered in England under number 7805321, at 389 Chiswick High Road, London W4 4AL, UK.
Contact Office: BSI Vietnam Headquarters - 15 Floor APC Tower, 5188 Den Bon Phu Street, Ward 21, Binh Thanh District, Ho Chi Minh City, Vietnam. Telephone: +84 (28) 38 200 066.
A member of the BSI Group of Companies.



DUYTAN PRECISION MOLD

CONTACT US



+84 28 3754 5418



+84 28 3754 5416



info@duytanmold.com



<http://duytanmold.com>



HEAD OFFICE

Block 1, 1A Road, Tan Tao
Industrial Zone, Tan Tao A Ward,
Binh Tan District, HCMC, VietNam



SCAN ME
Introduction Video



THANK YOU!