

DUYTAN PRECISION MOLD Co., Ltd



CÔNG TY TNHH KHUÔN CHÍNH XÁC

DUYTAN[®] ISO 9001:2015
ISO 14001:2015
ISO 45001:2018

PRECISION MOLD CO., LTD

LÔ 1, ĐƯỜNG 1A, KHC TÂN TẠO, P. TÂN TẠO A, Q. BÌNH TÂN, TP.HCM

SNAPSHOTS

- ▶ Taken apart from DUYTAN group since 2017.
- ▶ Twenty-two-year experiences in plastic mold design and manufacture, provide our customers comprehensive solution through closed processes from mold design, making mold, testing samples, manufacturing plastic products with injection and blowing processes, printing, labeling and delivery.
- ▶ Annual output: 350 – 400 high quality sets.
- ▶ 2019: Certificate on High Technology Enterprise issued by Ministry of Science & Technology.

Highlights

- *HQ Area: 8,250 m²*
- *Existing staff: 174 ppl (48 engineers)*
- *Main products: Precision molds*
- *Capacity: 350 - 400 sets/year*
- *Mold life achieve minimum: 300 → 1 million shots*
- *Mold precision: $\leq 5 - 10 \mu\text{m}$*

VISION
MISSION
CORE VALUES

*“To become a leading mold maker in Vietnam
and South East Asia ”*

*“To produce exquisite and high quality plastic
products that meet our customers' requirements”*

“Creation – Speed – Quality – Discipline”

OUR SERVICES

- Product design & concept to realization: Solution & 2D & 3D
- Reverse engineering & rapid prototype
- Mold design: analysis DFM, FMEA, Mold flow simulation
- Pilot mold manufacturing
- Production mold manufacturing
- Mold qualification

SEGMENTS SERVED

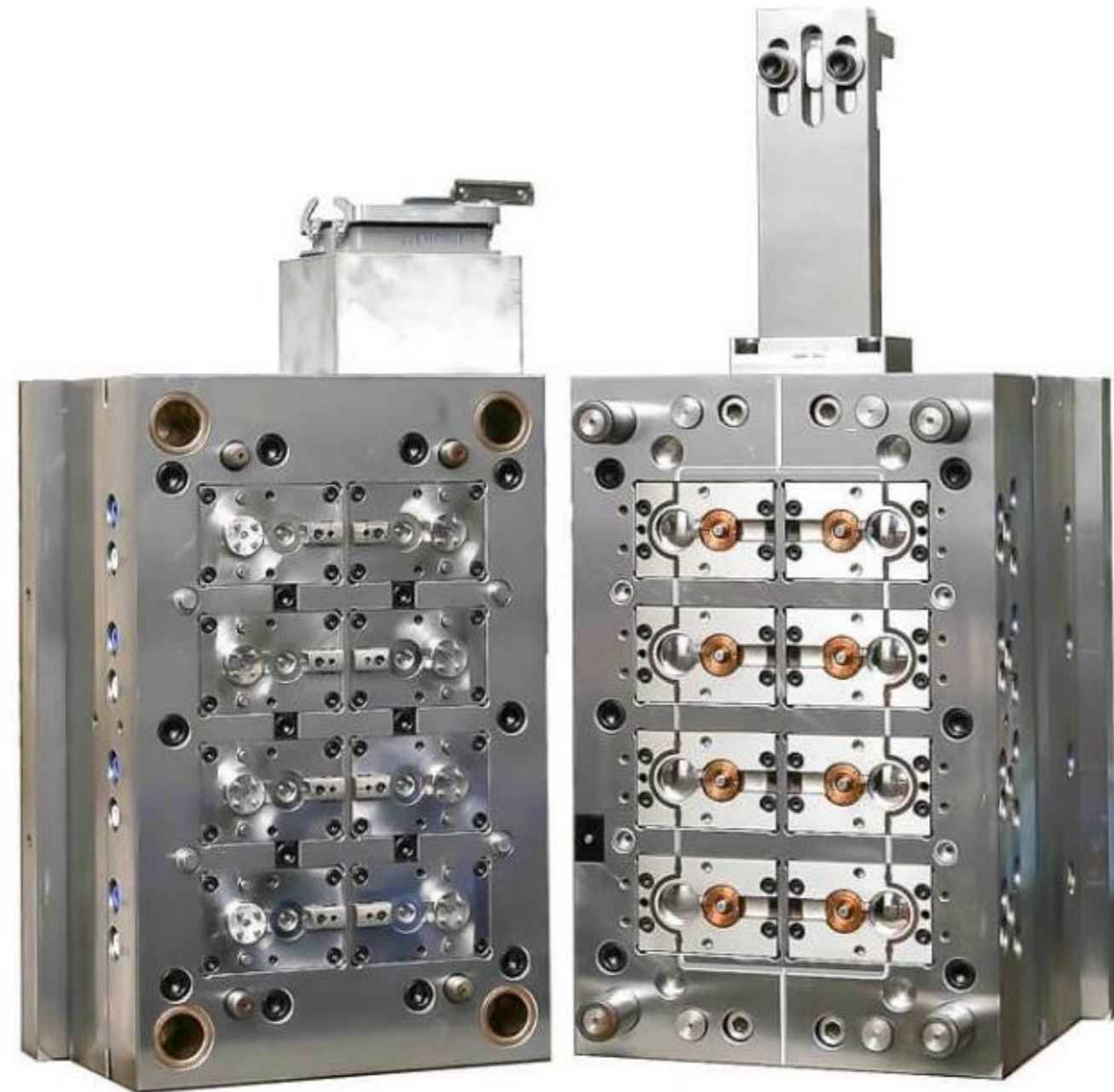

Injection molds for technical parts

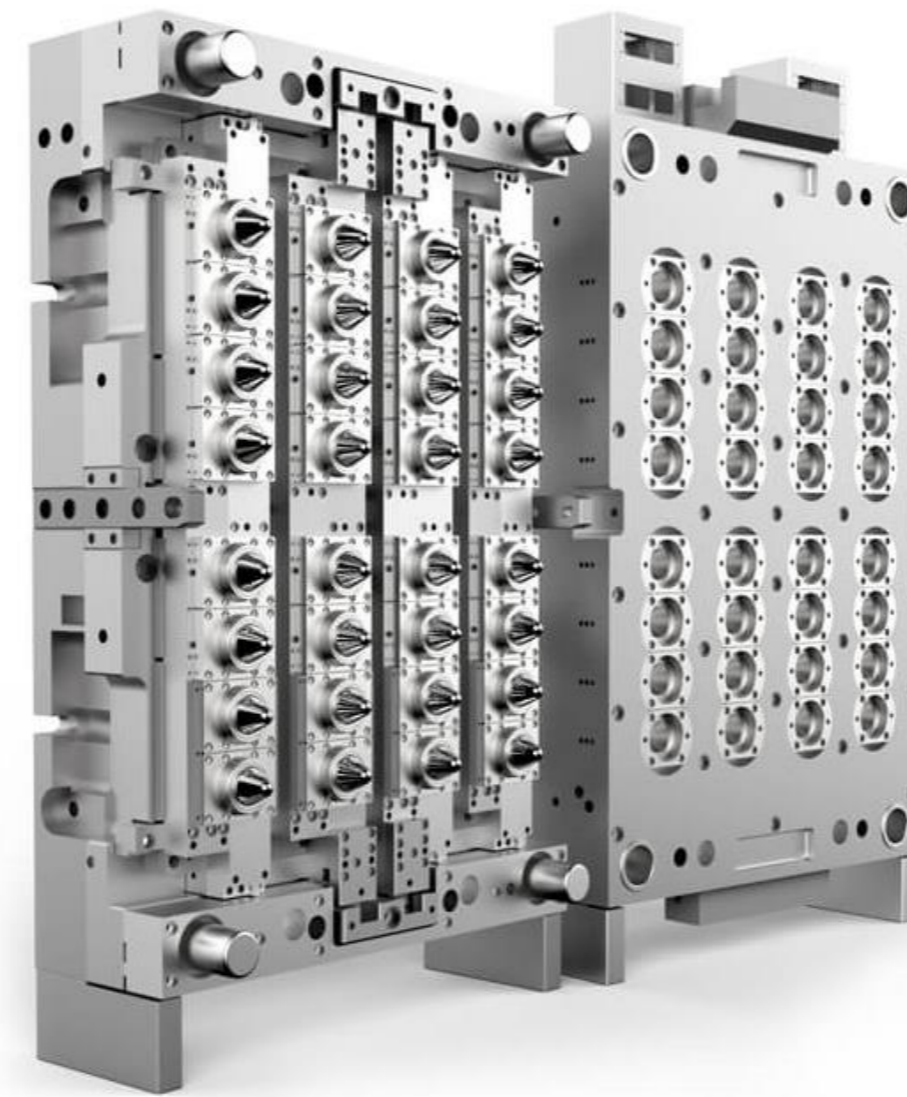

Injection molds for preform & caps & closures



Blowing mold for cosmetics jars / bottles

A produces about 350 sets of high precision molds per year

Our Partners & Customers

MACHINES/
EQUIPMENTS



SOFTWARES



CUSTOMERS

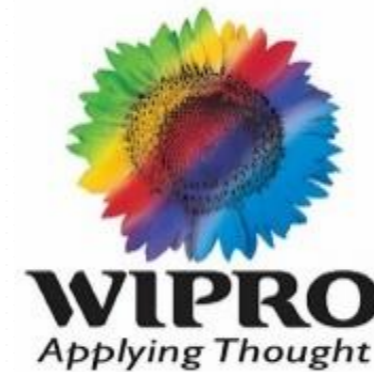

MOLD MANUFACTURING OVERVIEW



CUSTOMER
REQUEST



MOLD DESIGN

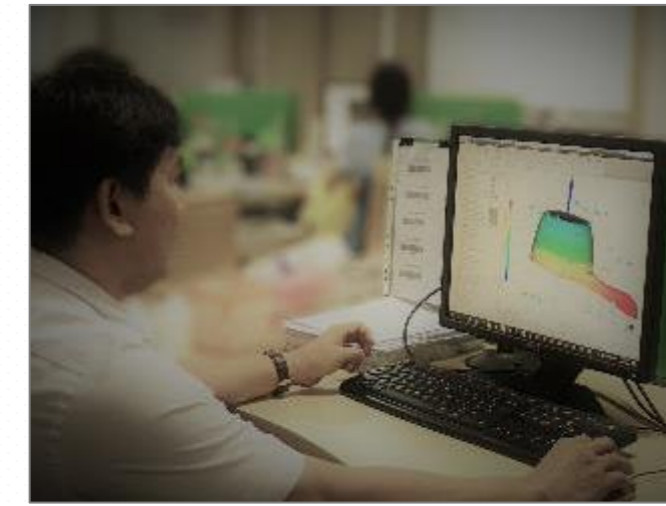

MOLD
MANUFACTURING



MOLD TRIAL



QA/QC AND
ACCEPTANCE

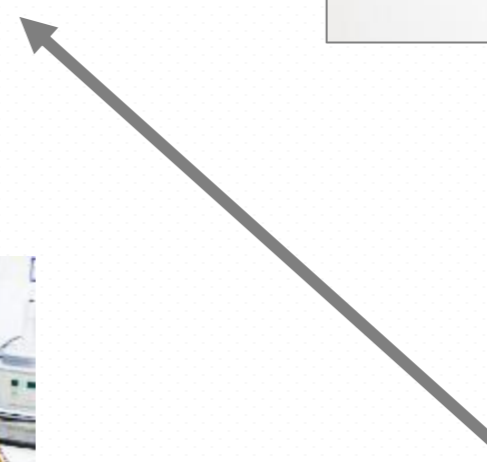

MOLD
ADJUSTMENT



DELIVERY/
HAND OVER



ANALYSIS & DESIGNING PROCESS

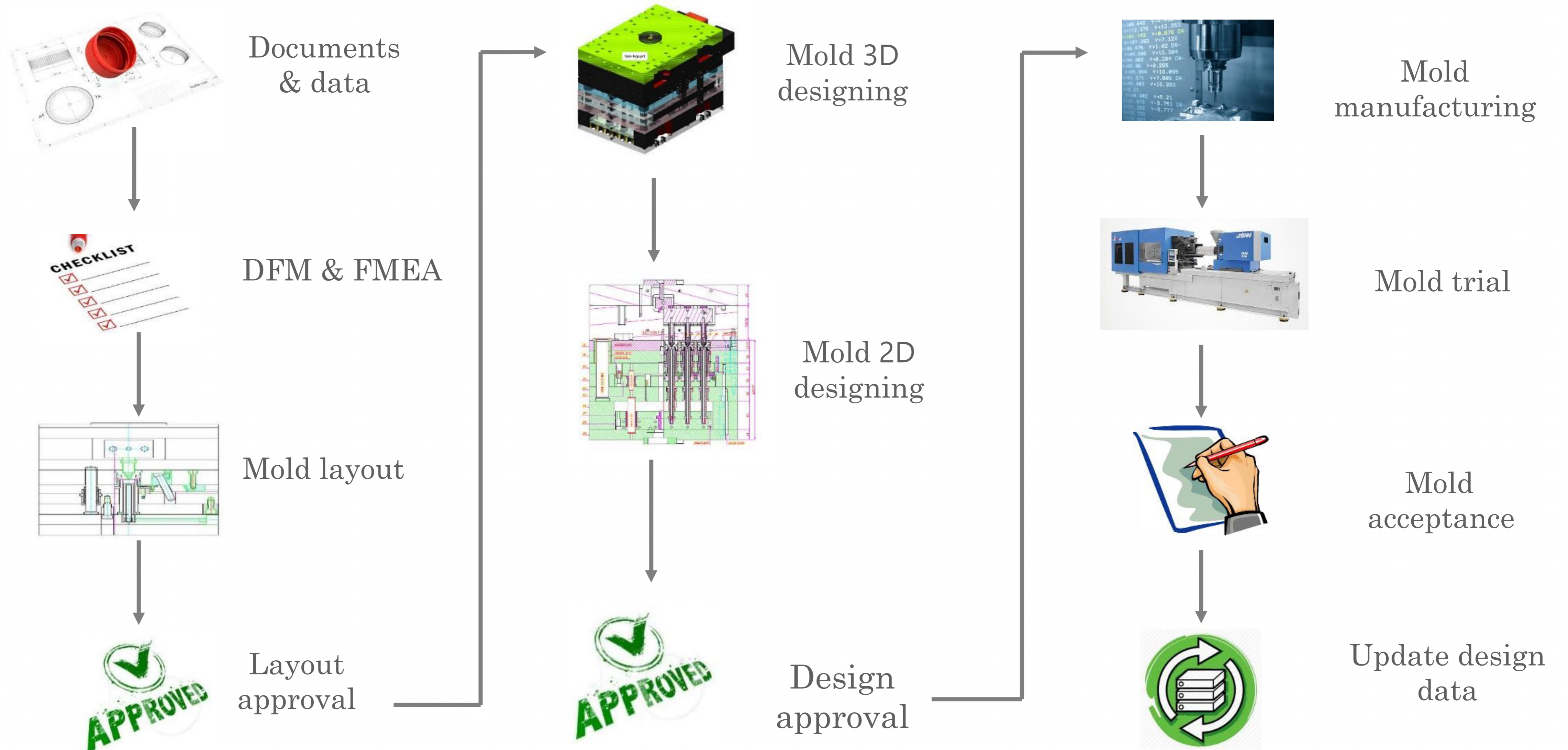

MANUFACTURING PROCESSING

Steel & materials

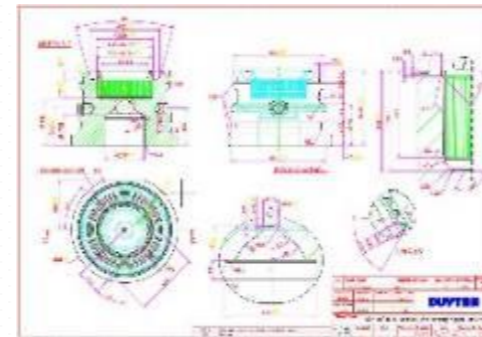

Manufacturing processing analysis basing on 3D&2D

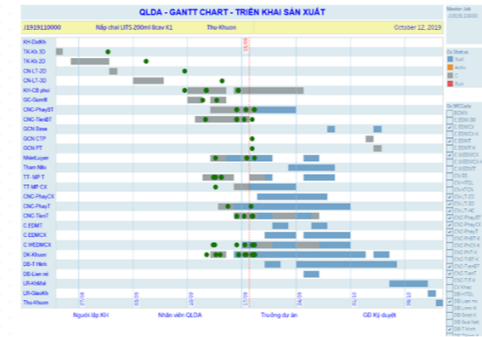

Processing scheduling



Mold components

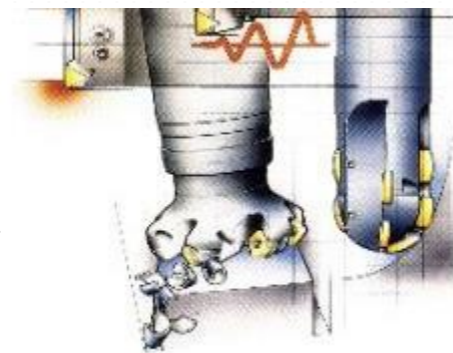

Rough machining
(Raw steel, rough milling & lathing)



Inserts finish machining
(Milling, lathing, EDM, grinding, ...)



Mold completing
(QC, polishing, assembly)

DESIGNING & PROCESS PROGRAMMING

- R&D: 15 engineers
- Designing & process programming: 20 engineers
- Technical analysis & design:
 - Pro Creo
 - Unigraphics
 - Hyper Mill
 - Solid Work
 - AutoCAD 2018
 - Mold Flow Analysis

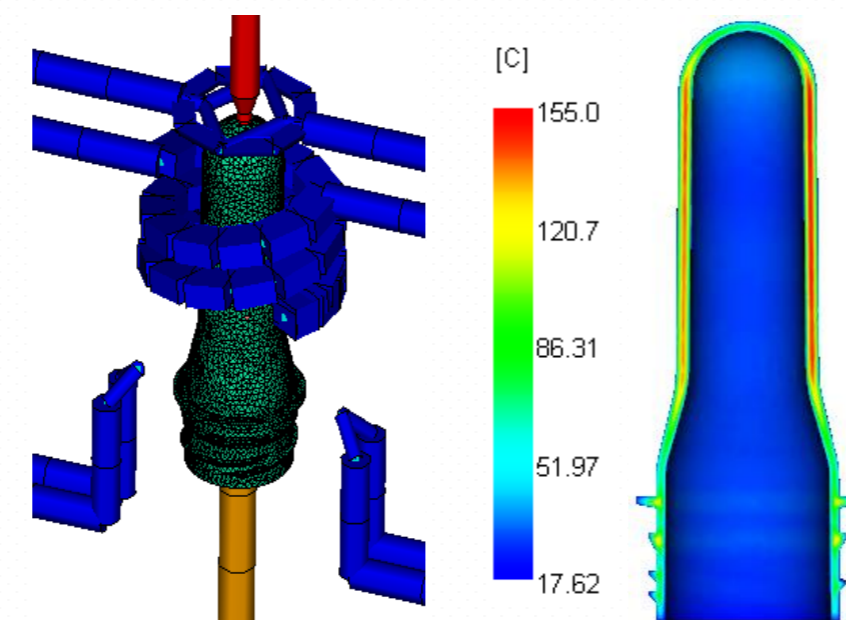
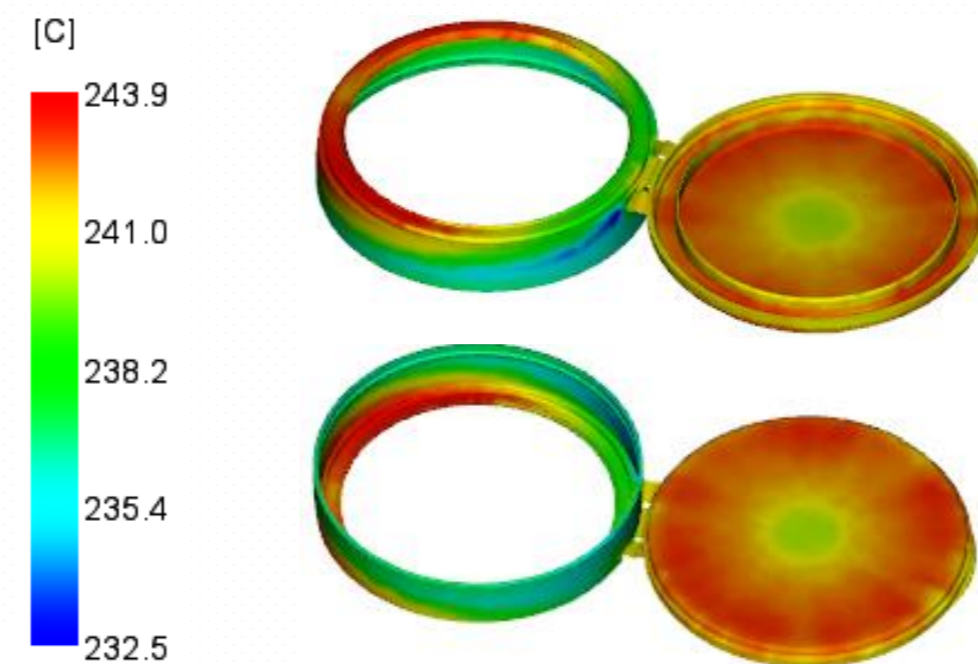

PROCESSING MANAGEMENT

Production Smoothing by ISS Software

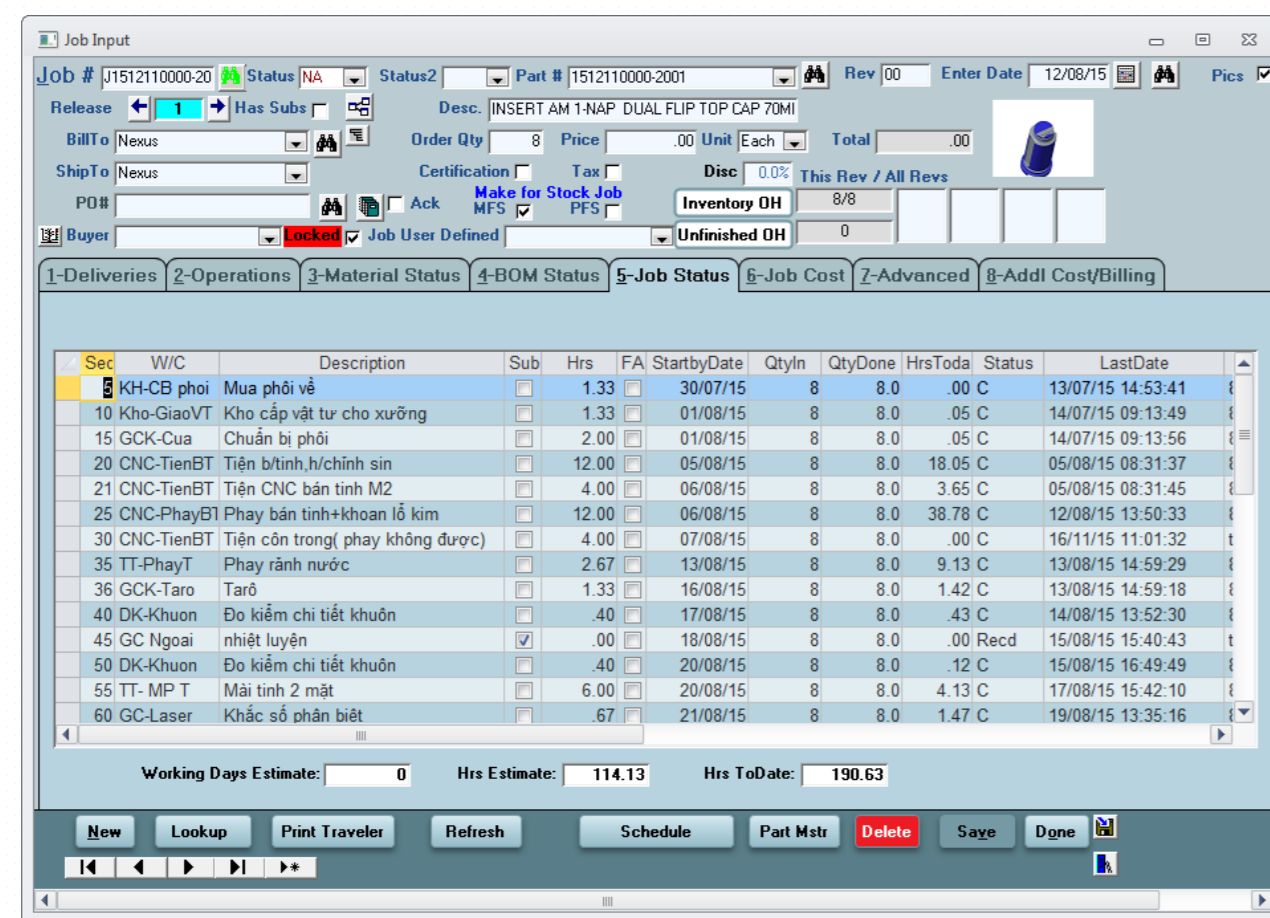

Dashboard Online Direct Management

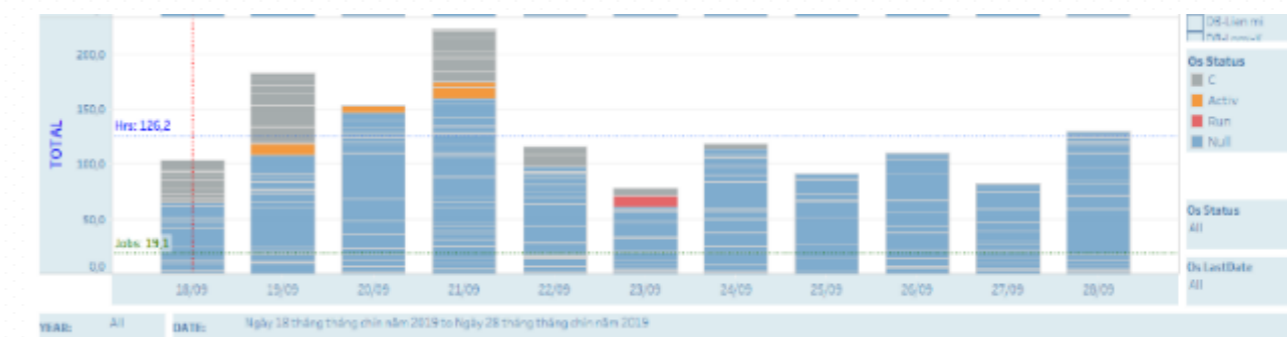
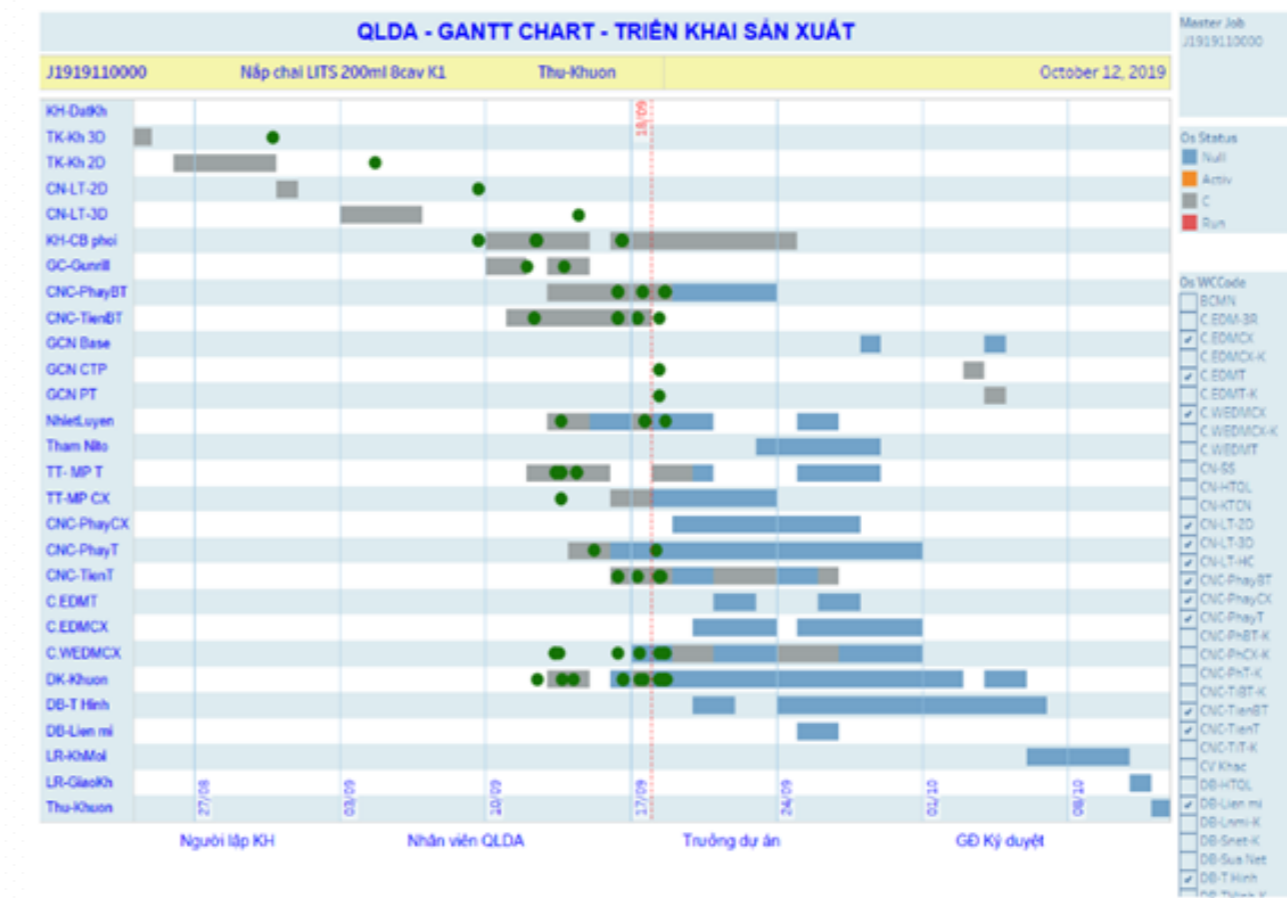

IoT

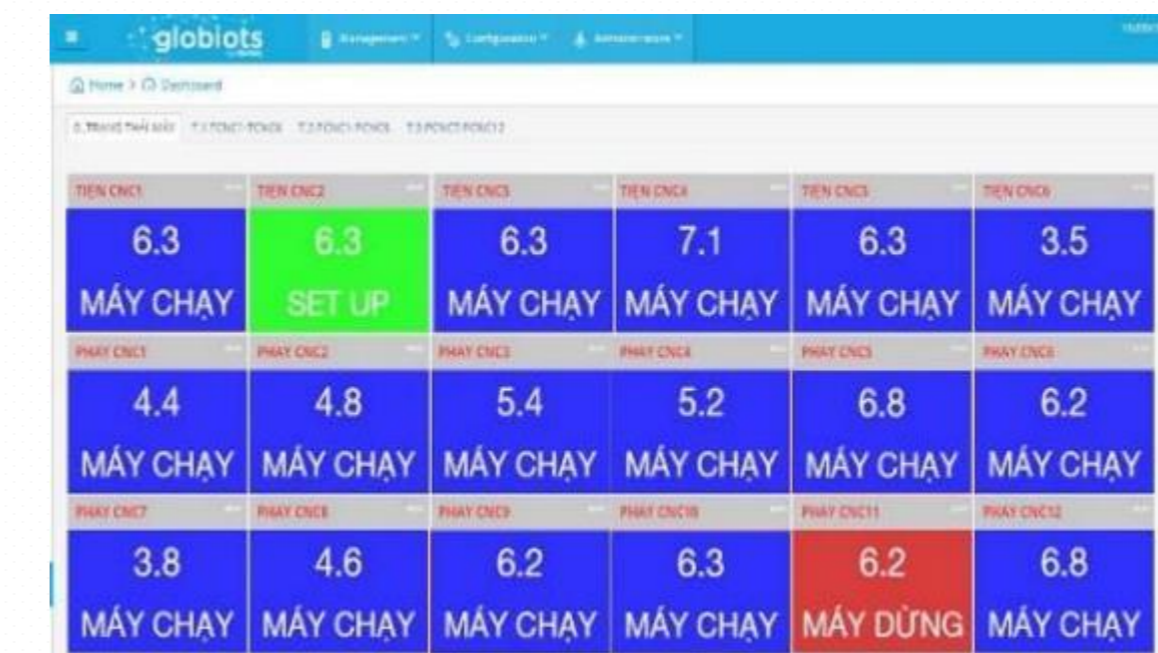
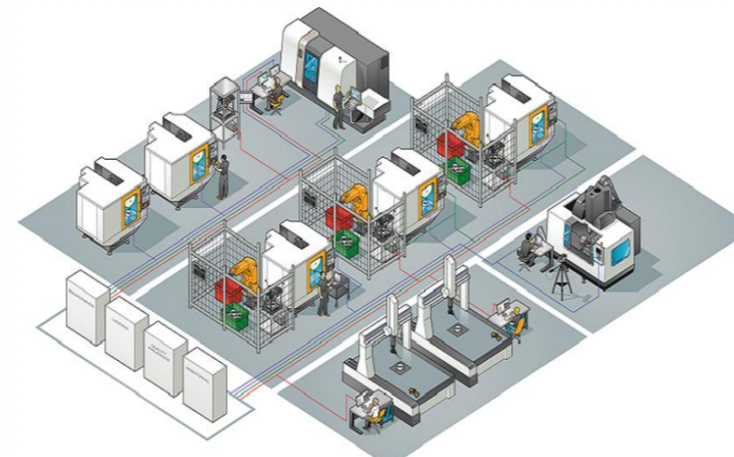

TECHNOLOGY



- Human : 175
- CNC milling : 14 machines
- CNC lathe : 7 machines
- EDM & WEDM : 6 machines

Processing: Rough & Finish Machining

*Milling machine
CNC MAZAK
FJV-35/80II*



*Milling machine
CNC MAZAK-
FJV-60/80II*



*Milling machine
CNC MAZAK-
VCS530*



Gun Drill machine



Processing: Grinding



Flat grinding machine
Okamoto ACC450



Circular grinding machine
Palmary GU32X60S

Processing: Finish Machining



Milling machines CNC 5 axis
Makino D500 (Japan)

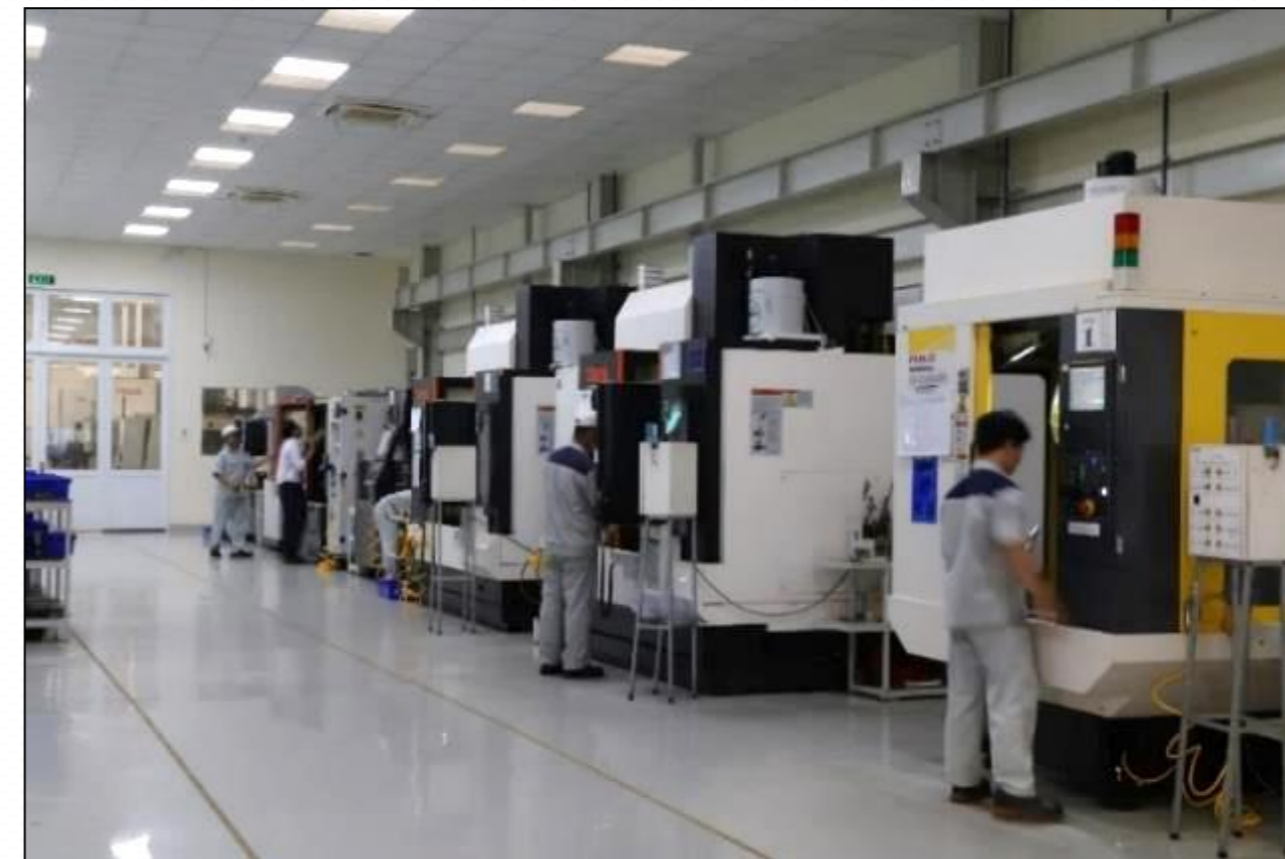

Processing: Finish Machining

LATHE MACHINE CNC MAZAK

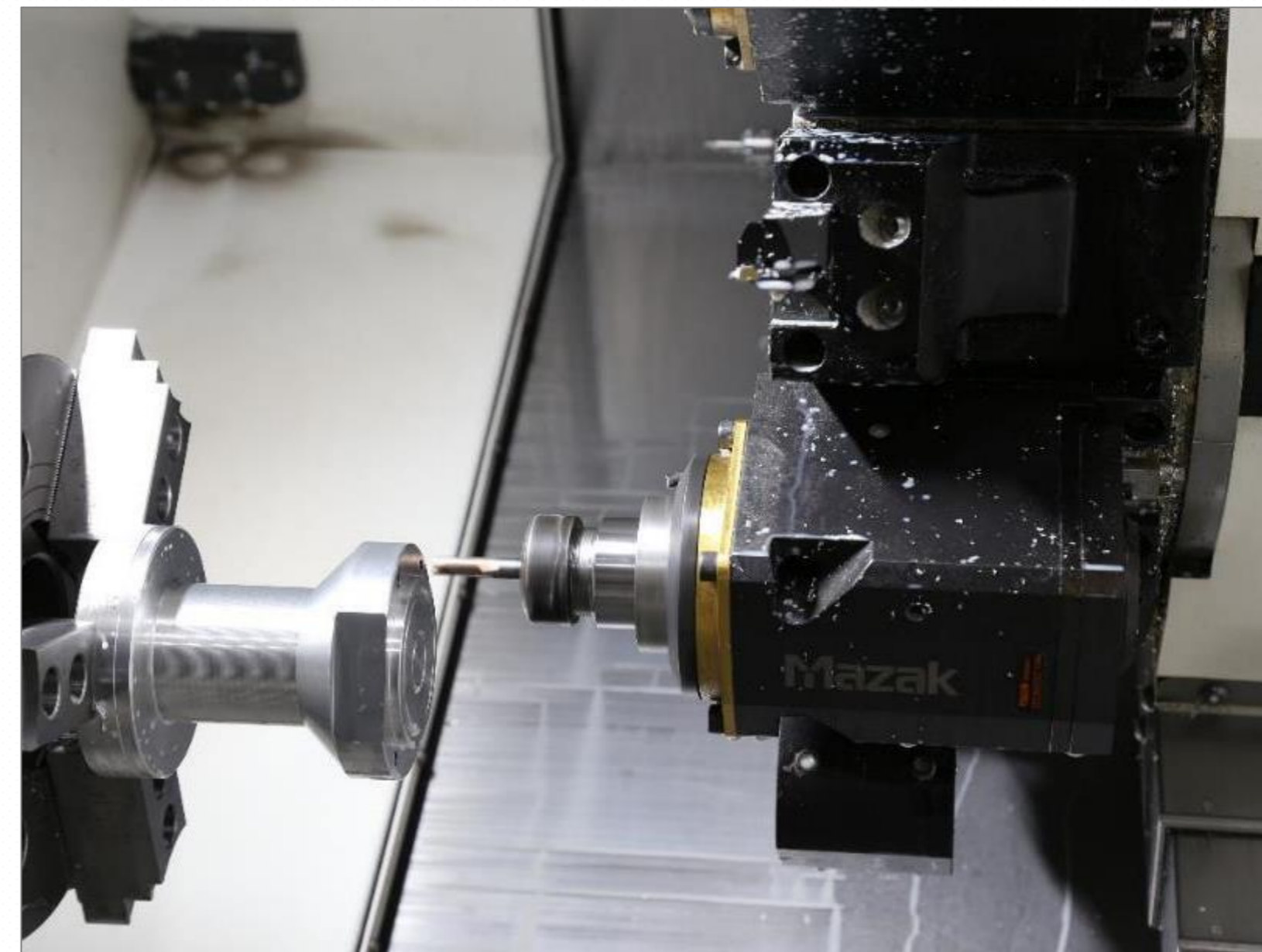

Lathe machine CNC Mazak QT300 MA, with C milling axis (Japan)

Processing: Finish Machining

EDM MACHINES



EDM Charmilles Roboform 35P
(Switzerland)



EDM Sodick AG40L
(Japan)

Processing: Finish Machining

WEDM MACHINES



Charmilles Robofil 380 (Switzerland)



Makino U3 (Japan)

MOLD TESTING MACHINES



JSW (JAPAN)



Krauss Maffei (GERMANY)

QUALITY ASSURANCE



**Projector Measuring -
Mitutoyo**



**Coordinate Measuring Machine
(CMM) - Mitutoyo**



**Height measuring
machine - Zoller**



**Hardness testing
machine**

CAP & CLOSURE



INJECTION MOLD

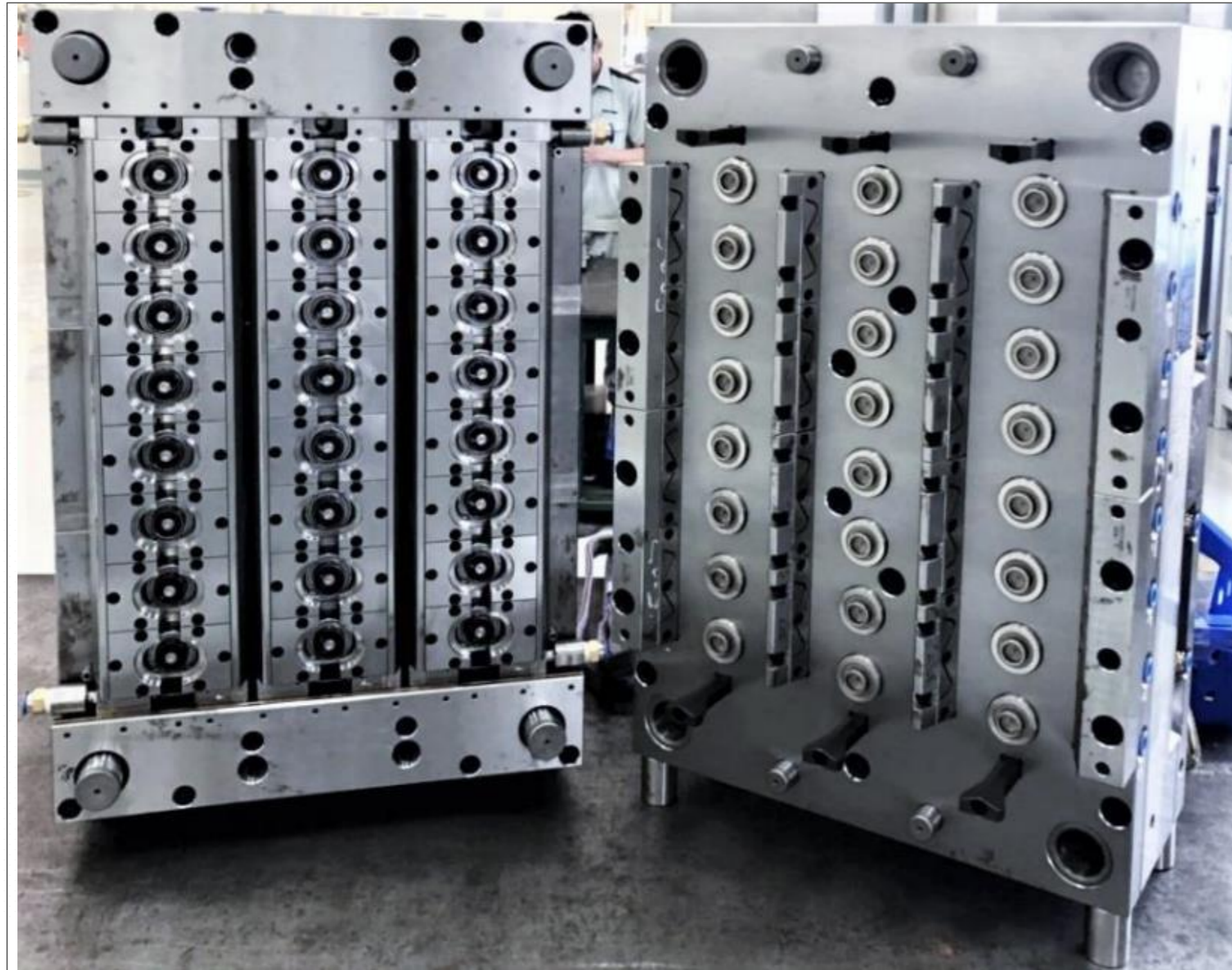

- Product : Effervescent tablets cap D31.9
- No. of cavity : 24 cav
- Resin : LDPE
- Part weight : 4.7g
- Machine: JSW ADS 180
- Cycle time: 24s
- Mold size: 700 x 500 x 597 (L x W x H)

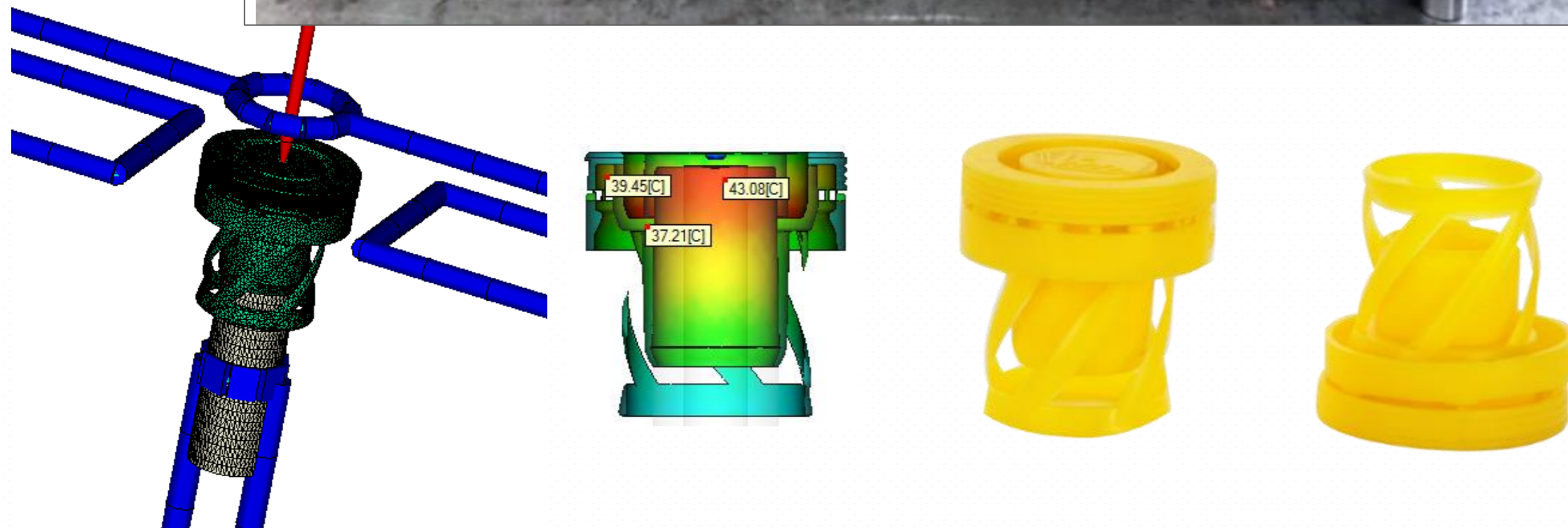

INJECTION MOLD

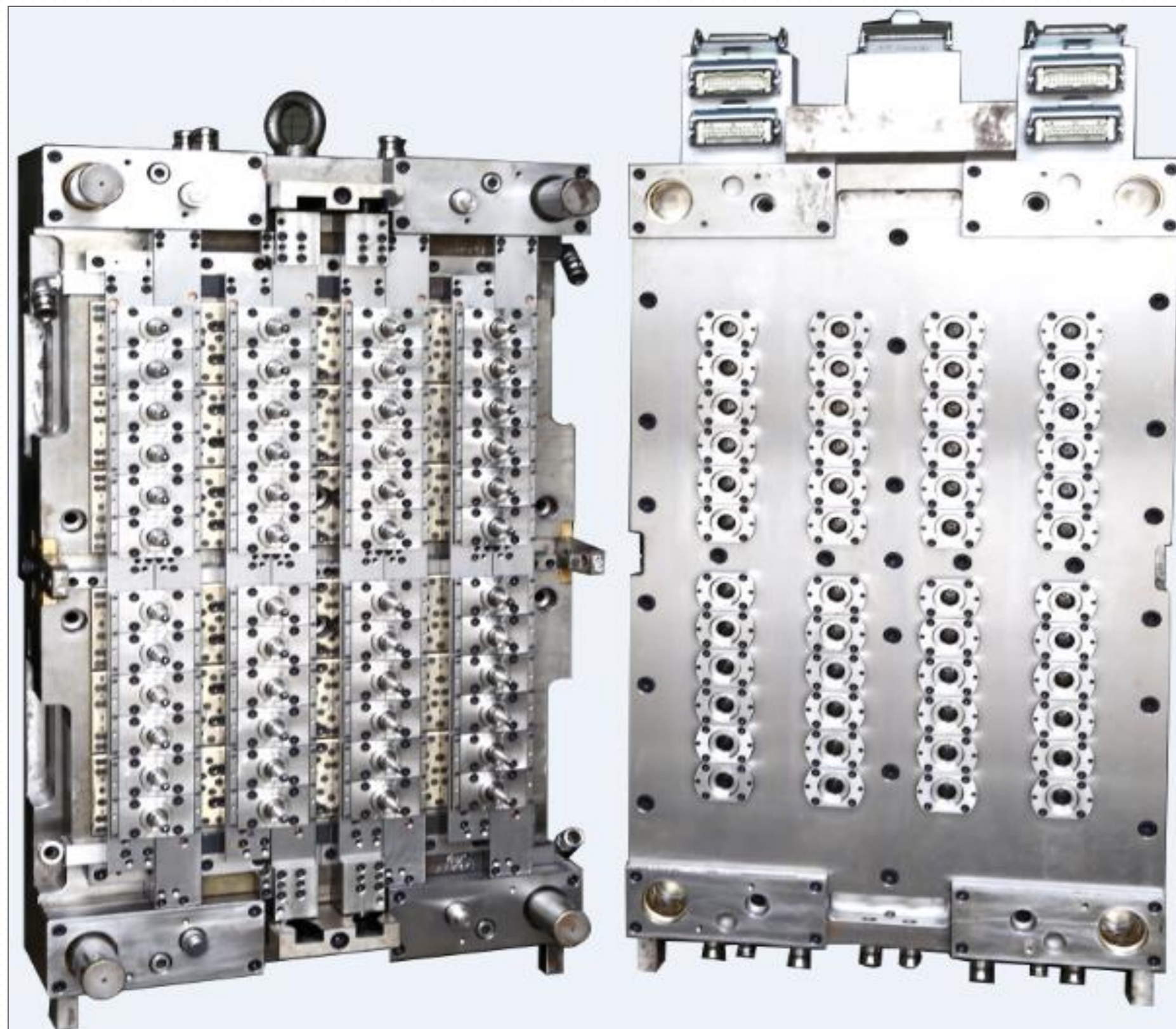

- Product: Preform D30 P30
- No. of cavity: 48cav
- No. of cavity: PET
- Part weight: 30g
- Machine: JSW ADS 450
- Cycle time: 30s
- Mold size: 1150x790x651 (L x W x H)

INJECTION MOLD

- Product: Edible oil fliptop cap D028 PCO1881
- No. of cavity: 16 cav
- Resin: LDPE & HDPE
- Part weight: 6.7g
- Machine: JSW ADS 180
- Cycle time: 18s
- Mold size: 750x490x521 (L x W x H)

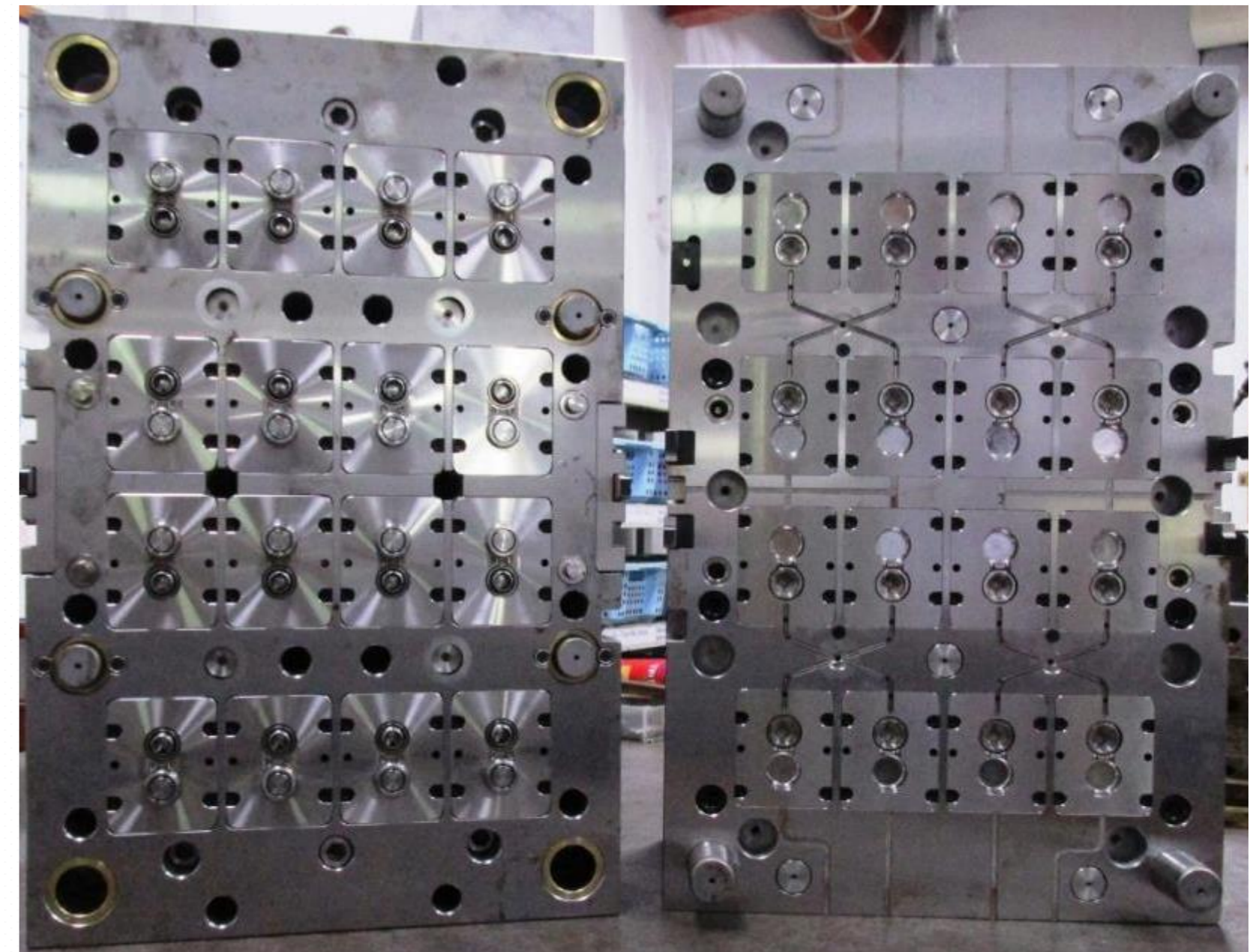

INJECTION MOLD



- Product: Fliptop 8oz Tall Snap On
- No. of cavity : 12cav
- Resin: PP
- Part weight: 13.6g
- Machine: JSW ADS 350
- Cycle time: 18s
- Mold size: 1050x700x527 (LxWxH)



INJECTION MOLD



- Product: Cap D60 stack mold
- No. of cavity: 16
- Resin: PP
- Part weight: 4.9g
- Machine: JSW ADS 110
- Cycle time: 12.5s
- Mold size: 550 x 400 x 446.8 (L x W x H)



INJECTION MOLD

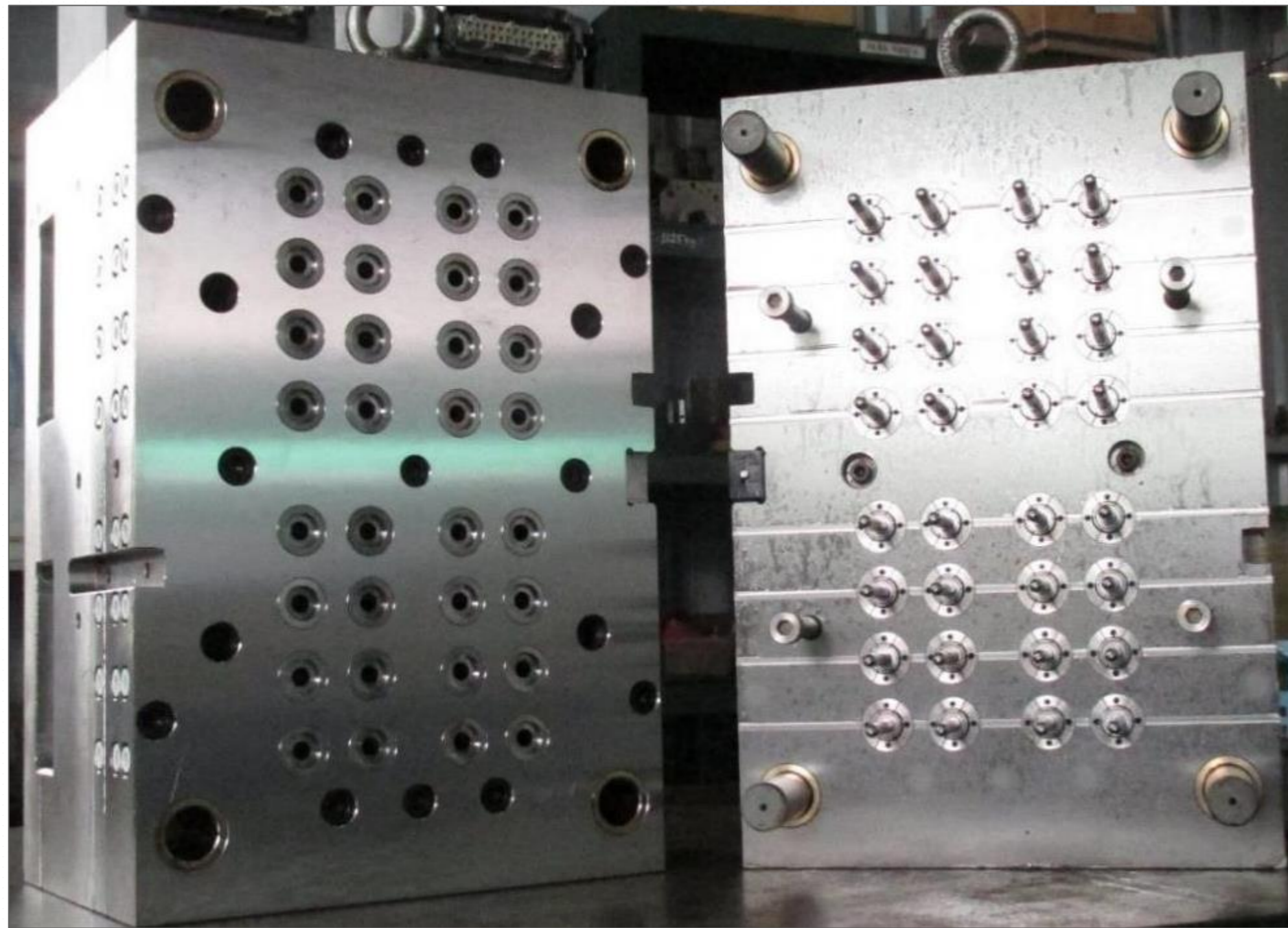

- Product: Blood tube
- No. of cavity: 32 cav
- Resin: PP
- Part weight: 2.2g
- Machine: Krauss Maffei 80
- Cycle: 8s
- Mold size: 600x400x443 (L x W x H)

BLOWING MOLD

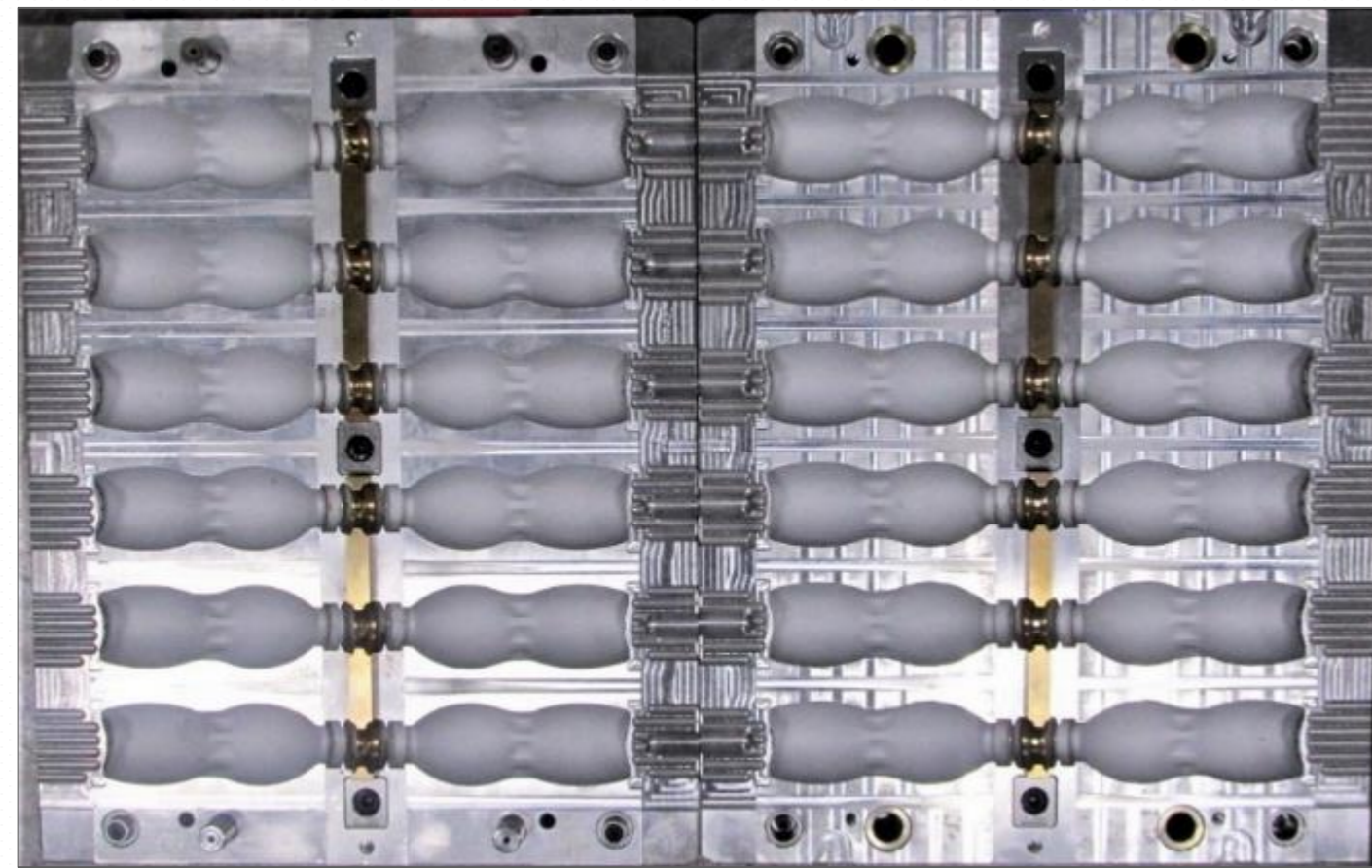



- No. of cavity: Max 12 cav
- Volume: 50ml -> 2.5 Litre



COMPANY MANAGEMENT SYSTEMS



bsi.  
By Royal Charter

Certificate of Registration

QUALITY MANAGEMENT SYSTEM - ISO 9001:2015



This is to certify that: **DUY TAN MOLD CO., LTD.**
Lot 1, Street 1A, Tan Tao Industrial Park,
Tan Tao A Ward, Binh Tan District,
Ho Chi Minh City,
Vietnam

Holds Certificate Number: **FM 721416**
and operates a Quality Management System which complies with the requirements of ISO 9001:2015 for the following scope:

The design, manufacture and supply of molds.



For and on behalf of BSI: 
Chris Cheung, Head of Compliance & Risk - Asia Pacific

Original Registration Date: 2020-02-20 Effective Date: 2020-02-20
Latest Revision Date: 2020-02-20 Expiry Date: 2023-02-19

   Page: 1 of 1
..making excellence a habit.™

This certificate was issued electronically and remains the property of BSI and is bound by the conditions of contract. An electronic certificate can be authenticated [via https://www.bsi-global.com/ClientDirectory](https://www.bsi-global.com/ClientDirectory) or telephone +44 (0) 300 9005. Further clarifications regarding the scope of this certificate and the applicability of ISO 9001:2015 requirements may be obtained by consulting the organisation. This certificate is valid only if provided original copies are in complete set.

Information and Contact: BSI, Kitemark Court, Davy Avenue, Knowlhill, Milton Keynes MK5 8PR. Tel: +44 345 080 9000
BSI Assurance UK Limited, registered in England under number 7505221 at 389 Chiswick High Road, London W4 4AL, UK.
A Member of the BSI Group of Companies.

bsi.  
By Royal Charter

Certificate of Registration

ENVIRONMENTAL MANAGEMENT SYSTEM - ISO 14001:2015



This is to certify that: **DUY TAN MOLD CO., LTD.**
Lot 1, Street 1A, Tan Tao Industrial Park,
Tan Tao A Ward, Binh Tan District,
Ho Chi Minh City,
Vietnam

Holds Certificate Number: **EMS 721414**
and operates an Environmental Management System which complies with the requirements of ISO 14001:2015 for the following scope:

The design, manufacture and supply of molds.

For and on behalf of BSI: 
Chris Cheung, Head of Compliance & Risk - Asia Pacific

Original Registration Date: 2020-02-20 Effective Date: 2020-02-20
Latest Revision Date: 2020-02-20 Expiry Date: 2023-02-19

   Page: 1 of 1
..making excellence a habit.™

This certificate was issued electronically and remains the property of BSI and is bound by the conditions of contract. An electronic certificate can be authenticated [via https://www.bsi-global.com/ClientDirectory](https://www.bsi-global.com/ClientDirectory) or telephone +44 (0) 300 9005. Further clarifications regarding the scope of this certificate and the applicability of ISO 14001:2015 requirements may be obtained by consulting the organisation. This certificate is valid only if provided original copies are in complete set.

Information and Contact: BSI, Kitemark Court, Davy Avenue, Knowlhill, Milton Keynes MK5 8PR. Tel: +44 345 080 9000
BSI Assurance UK Limited, registered in England under number 7505221 at 389 Chiswick High Road, London W4 4AL, UK.
A Member of the BSI Group of Companies.

bsi.  
By Royal Charter

Certificate of Registration

OCCUPATIONAL HEALTH & SAFETY MANAGEMENT SYSTEM - ISO 45001:2018

This is to certify that: **DUY TAN MOLD CO., LTD.**
Lot 1, Street 1A, Tan Tao Industrial Park,
Tan Tao A Ward, Binh Tan District,
Ho Chi Minh City,
Vietnam

Holds Certificate Number: **OHS 721418**
and operates an Occupational Health and Safety Management System which complies with the requirements of ISO 45001:2018 for the following scope:

The design, manufacture and supply of molds.

For and on behalf of BSI: 
Chris Cheung, Head of Compliance & Risk - Asia Pacific

Original Registration Date: 2020-02-20 Effective Date: 2020-02-20
Latest Revision Date: 2020-02-20 Expiry Date: 2023-02-19

  Page: 1 of 1
..making excellence a habit.™

This certificate was issued electronically and remains the property of BSI and is bound by the conditions of contract. An electronic certificate can be authenticated [via https://www.bsi-global.com/ClientDirectory](https://www.bsi-global.com/ClientDirectory) or telephone +44 (0) 300 9005. Further clarifications regarding the scope of this certificate and the applicability of ISO 45001:2018 requirements may be obtained by consulting the organisation. This certificate is valid only if provided original copies are in complete set.

Information and Contact: BSI, Kitemark Court, Davy Avenue, Knowlhill, Milton Keynes MK5 8PR. Tel: +44 345 080 9000
BSI Assurance UK Limited, registered in England under number 7505221 at 389 Chiswick High Road, London W4 4AL, UK.
A Member of the BSI Group of Companies.



CONTACT US



+84 28 3754 5418



+84 28 3754 5416



info@duytanmold.com



<http://duytanmold.com>



HEAD OFFICE

Block 1, 1A Road, Tan Tao Industrial Zone, Tan Tao A Ward, Binh Tan District, HCMC, Vietnam



SCAN ME
Introduction Video